

TECHNICAL MANUAL
ORGANIZATIONAL, DIRECT SUPPORT
AND GENERAL SUPPORT
MAINTENANCE
FOR
ELECTRICAL SURGE ARRESTER

THIS PUBLICATION IS A COURTESY QUICK FROM THE UNITED STATES ARMY PUBLICATIONS DISTRIBUTION CENTER, ST. LOUIS MISSOURI TO MEET YOUR NEEDS WHILE WE REPLENISH OUR REGULAR STOCK.

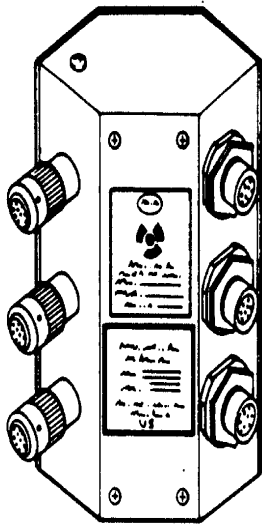

F-1483/G
 (NSN 5920-01-093-6969)

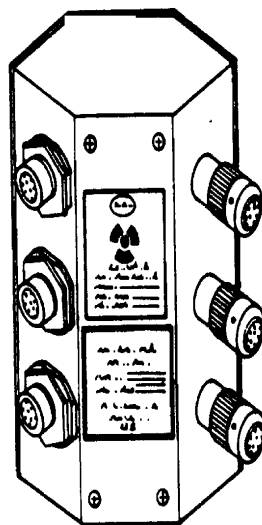

F-1495/G
 (NSN 5920-01-093-6970)

EQUIPMENT DESCRIPTION AND DATA	1-6
---------------------------------------	------------

ORGANIZATIONAL PMCS	2-2
----------------------------	------------

ORGANIZATIONAL TROUBLESHOOTING	2-4
---------------------------------------	------------

SERVICE UPON RECEIPT	3-2
-----------------------------	------------

INSTALLATION	3-5
---------------------	------------

TESTING	3-9
----------------	------------

DS AND GS TROUBLESHOOTING	3-15
----------------------------------	-------------

**WARNING
RADIATION HAZARD**

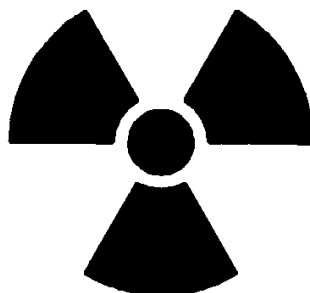

**RADIOACTIVE MATERIAL
CONTROLLED DISPOSAL REQUIRED
ACCOUNTABILITY NOT REQUIRED**

The components of the Electrical Surge Arrester are potentially hazardous when broken. See qualified medical personnel and the local Radiological Protection Officer (RPO) immediately if you are exposed to or cut by broken components. First aid instructions are contained in TB 43-0116, TB 43-0122, and AR 385-11.

Wear protective gloves when handling components that may have been in contact with a damaged arrester.

WHEN AN ARRESTER IS DAMAGED AND INTERNAL COMPONENTS ARE EXPOSED DO NOT HANDLE: REFER DISPOSAL TO QUALIFIED PERSONNEL WHO ARE AUTHORIZED TO HANDLE RADIOACTIVE (NUCLEAR) MATERIAL.

WARNING

ELECTRICAL HAZARD

Be aware that dangerous voltages exist within the shelter and in locations where the arresters are installed. Turn off shelter equipment power before disconnecting and removing an arrester.

WARNING

RESPIRATORY HAZARD

Adequate ventilation should be provided while using TRICHLOROTRIFLUOROETHANE. Prolonged breathing of vapor should be avoided. The solvent should not be used near heat or open flame; the products of decomposition are toxic and irritating. Since TRICHLOROTRIFLUOROETHANE dissolves natural oils, prolonged contact with skin should be avoided. When necessary, use gloves which the solvent cannot penetrate. If the solvent is taken internally, consult a physician immediately.

**ORGANIZATIONAL, DIRECT SUPPORT AND GENERAL SUPPORT
MAINTENANCE
FOR
ELECTRICAL SURGE ARRESTER F-14951G
(NSN 5920-01-093-6970)
AND
ELECTRICAL SURGE ARRESTER F-1483/G
(NSN 5920-01-093-6969)**

REPORTING ERRORS AND RECOMMENDING IMPROVEMENTS

You can help improve this manual. If you find any mistakes or if you know of a way to improve the procedures, please let us know. Mail your letter, DA Form 2028 (Recommended Changes to Publications and Blank Forms), or DA Form 2028-2 located in the back of this manual direct to: Commander, US Army Communications-Electronics command, ATTN: DRSEL-ME-MO, Fort Monmouth, New Jersey 07703. In either case, a reply will be furnished direct to you.

		PAGE
HOW TO USE THIS MANUAL		iii
CHAPTER 1	INTRODUCTION	
Section I	General Information	1-1
	II Equipment Description and Data	1-6
	III Principles of Operation.....	1-10
CHAPTER 2	ORGANIZATIONAL MAINTENANCE	
Section I	Repair Parts, Special Tools, TMDE and Support Equipment	2-1
	II Preventive Maintenance Checks and Services (PMCS)	2-2
	III Troubleshooting	2-4
CHAPTER 3	DIRECT SUPPORT AND GENERAL SUPPORT MAINTENANCE	
Section I	Repair Part, Special Tools, TMDE and Support Equipment	3-1
	II Service Upon Receipt	3-2
	III Installation.....	3-5
	IV Testing	3-9
	V Troubleshooting	3-15
APPENDIX A	REFERENCES	A-1
	B COMPONENTS OF END ITEM LIST (COEIL) (Not Applicable)	
	C ADDITIONAL AUTHORIZATION LIST (AAL) (Not Applicable)	
	D MAINTENANCE ALLOCATION	
Section I	Introduction	D-1
	II Maintenance Allocation Chart	D-3
	III Tool and Test Equipment Requirements	D-4
	IV Remarks	D-5

HOW TO USE THIS MANUAL

This manual has been prepared in an ascending numbered order of Chapters, Sections and Paragraphs.

The Chapters are numbered Chapter 1, Chapter 2 and Chapter 3. Each Chapter contains Sections given in Roman numeral order such as Section 1, 11, and Iii in Chapters 1 and 2 and such as Section 1, 11, III, IV and V in Chapter 3.

The Paragraphs are In numerical order in each Chapter. Each Paragraph has the Chapter number given before the sequential number of the Paragraph. For example Paragraph 1-1 is the first paragraph In Chapter 1. Paragraph 2-1 is the first paragraph in Chapter 2 and so on throughout the manual.

A bullet (.) indicates additional Information needed for the Paragraph above It.

A locator is provided on the right-hand border of the front cover. This gives the location In the manual of the Information most frequently needed.

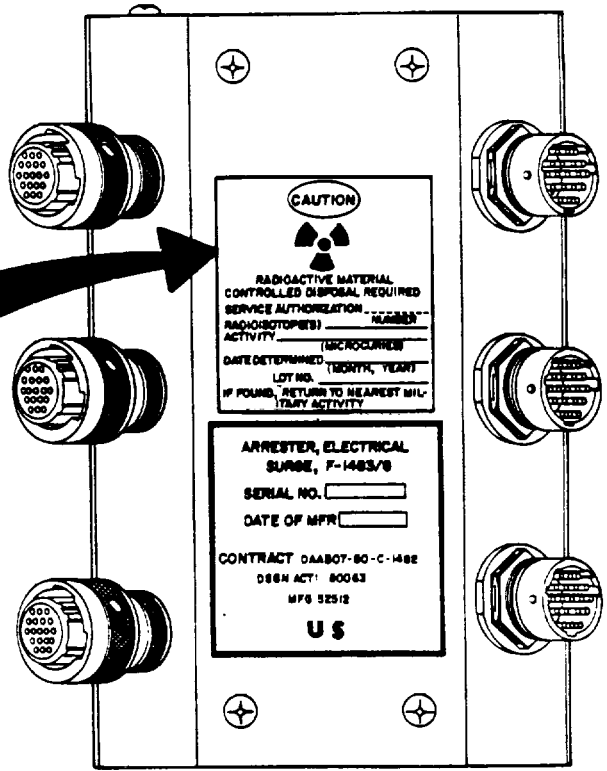

F-1483/G

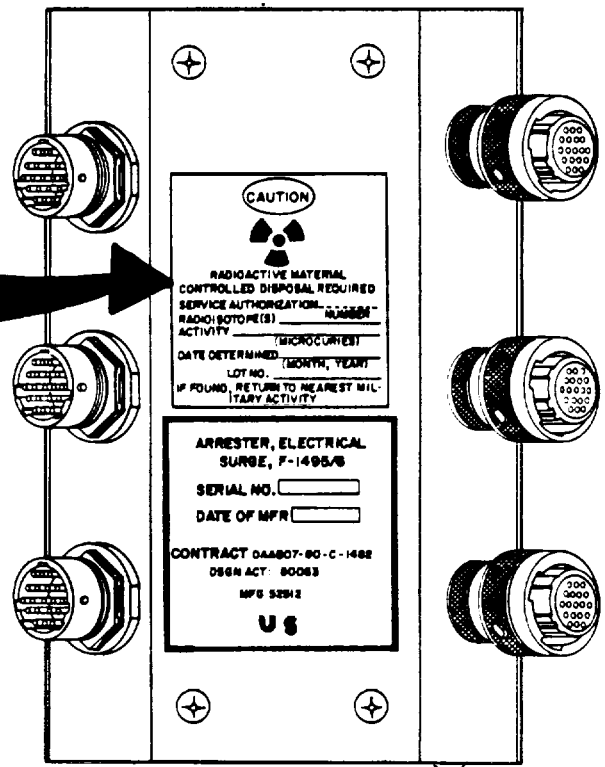

F-1495/G

NOTE

The CAUTION label (decal) for RADIOACTIVE MATERIAL will be on arresters that have radioactive material components. The WARNING notices in this manual do not apply to arresters without the CAUTION label (decal).

**CHAPTER 1
INTRODUCTION**

SECTION I. GENERAL INFORMATION

Section Contents	Paragraph
Scope.....	1-1
Maintenance Forms, Records, and Reports.....	1-2
Reporting Equipment Improvement Recommendations (EIR) ...	1-3
Destruction of Army Electronics Materiel.....	1-4
Nomenclature Cross-Reference List	1-5

1-1. SCOPE

This manual cover organizational, direct and general support maintenance.

PURPOSE OF EQUIPMENT

The equipment protects signal equipment input circuits from high energy induced voltages which may come from:

- A high altitude nuclear explosion.
- Lightning during electrical storms.
- High radiation equipment such as radar and microwave equipment.

or

- Accidental contact with electrical power lines.

MODEL NUMBERS AND EQUIPMENT NAMES

Two units, electrically identical, are described below. The units are made for use at specific locations.

- Electrical Surge Arrester F-1483/G has signal CHANNEL input connectors on your left-hand side facing the unit. This unit will be called the roadside arrester throughout this manual.

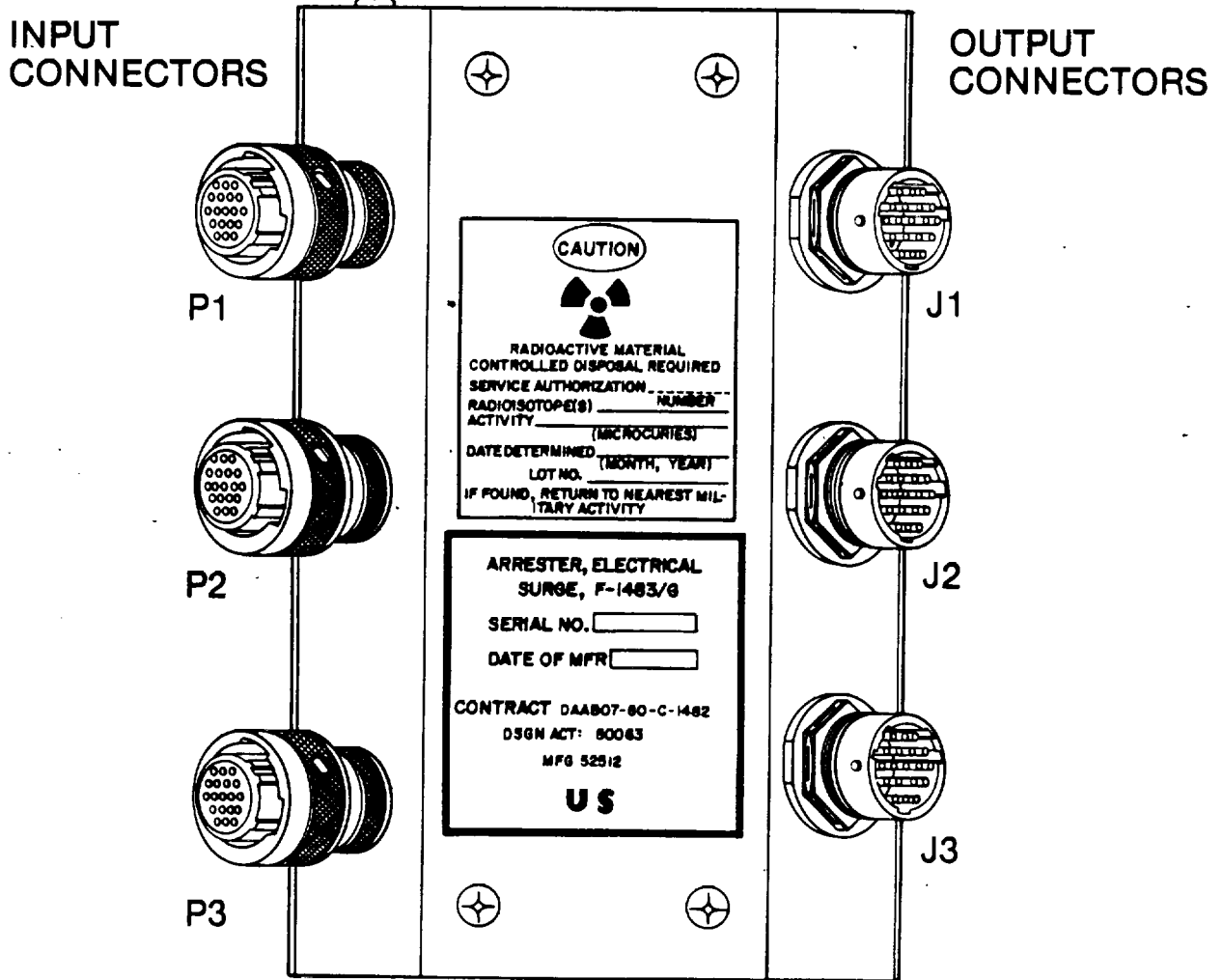

F-1483/G

- Electrical Surge Arrester F-1495/G has signal CHANNEL Input connectors on your right-hand side facing the unit. This unit will be called the curbside arrester throughout this manual.

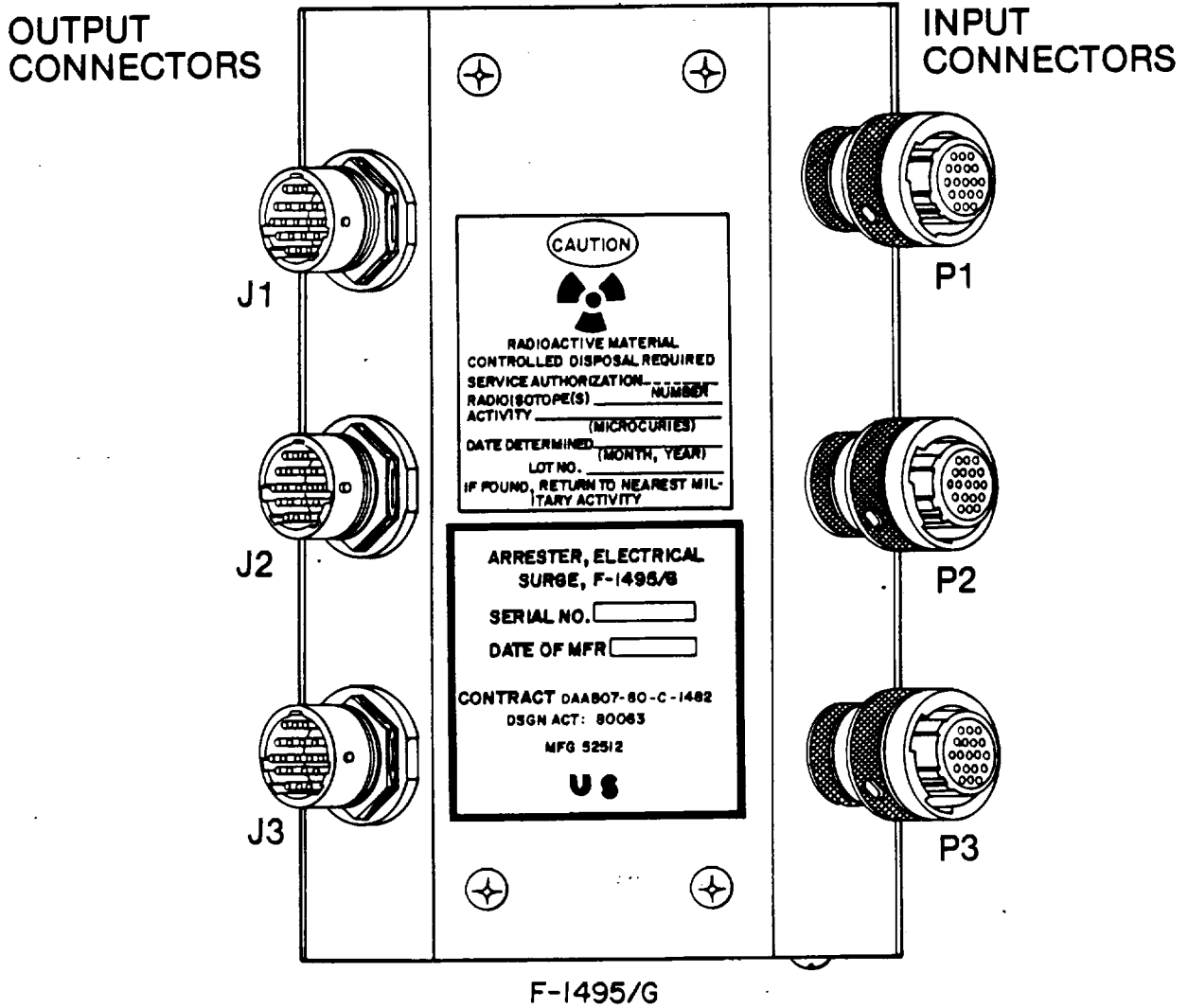

1-2. MAINTENANCE-FORMS, RECORDS, AND REPORTS

Department of the Army forms and procedures used for equipment maintenance will be those prescribed by TM 38-750, The Army Maintenance Management System.

1-3. REPORTING EQUIPMENT IMPROVEMENT RECOMMENDATIONS (EIR)

If your equipment needs improvement, let us know. Send us an EIR. You, the user, are the only one who can tell us what you don't like about your equipment. Let us know why you don't like the design. Tell us why a procedure is hard to perform. Put it on an SF 368 (Quality Deficiency Report). Mail it to Commander, US Army Communications-Electronics Command, ATTN: DRSEL-ME-MQ, Fort Monmouth, New Jersey 07703. We'll send you a reply.

1-4. DESTRUCTION OF ARMY ELECTRONICS MATERIEL

Destruction of Army electronics materiel to prevent enemy use shall be in accordance with TM 750-244-2.

1-5. NOMENCLATURE CROSS-REFERENCE LIST

The list below gives the nomenclature and common names that are used in this manual.

COMMON NAME	NOMENCLATURE
Roadside arrester	Electrical Surge Arrester F-14831G
Curbside arrester	Electrical Surge Arrester F-1495/G
TS-352B/U or Multimeter	Multimeter TS-352B/U
TS-3760/G (Go-no go tester)	Test Set TS-3760/G

The short nomenclature (CS-3760/G) is used in this manual. Other publications In making reference to Test Set TS-3760/G, may refer to it as a go-no go tester. Therefore both common names are given here.

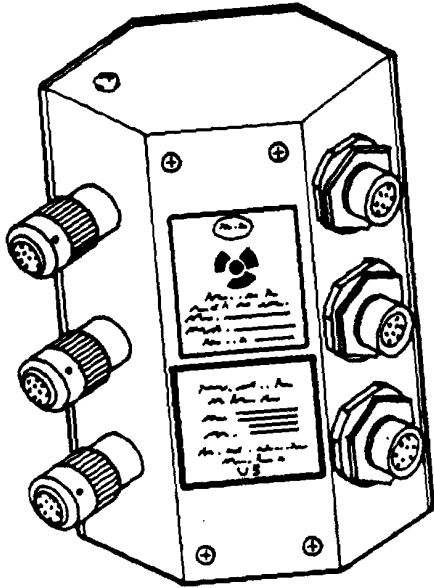

F-1483/G

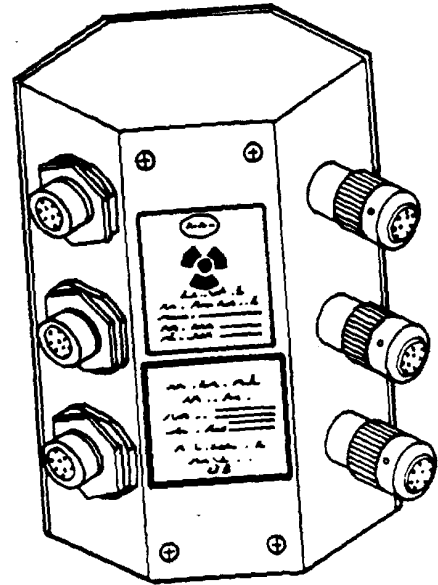

F-1495/G

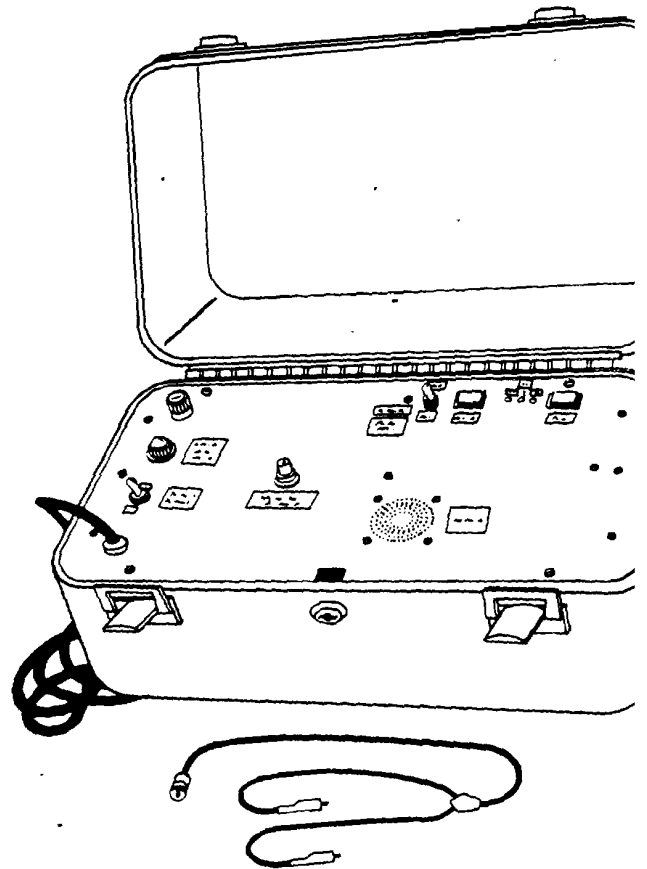
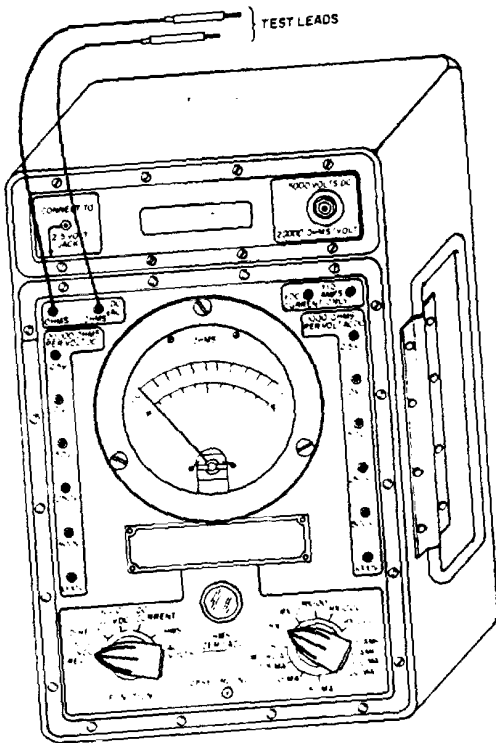

Test Set TS-3760/G

SECTION II. EQUIPMENT DESCRIPTION AND DATA

Section Contents	Paragraph
Capability and Features	1-6
Characteristics	1-7
Location and Description of Major Components.....	1-8
Safety, Care and Handling.....	1-9

1-6. CAPABILITY AND FEATURES

CAPABILITY

The arrester provides 48 input lines (circuits to communications equipment connected to external input lines (circuits)). The arrester purpose is to inhibit (stop) external high energy induced voltages from damaging the communications equipment.

Since the external cables and lines are the ones subject to the high energy induced voltages, the arrester protects the communications equipment from the high energy induced voltages.

FEATURES

Each of the 48 lines of the arrester has a spark gap which shorts out any high energy induced voltage resulting from lightning or a nuclear explosion.

Each of the 48 lines of the arrester has a transorb (back-to-back diode) which prevents the line (circuit) voltage from exceeding 140 volts in the negative and positive direction from ground.

The arrester has 48 lines (circuits), therefore the arrester will provide protection for 12 4-wire channels.

The arresters are to be used in a shelter environment, and are not intended for use in weather conditions where moisture is present.

The arrester consists of passive networks (operating dc power is not used and circuit components are not intended to alter the output signals). Therefore more than one arrester can be used with only physical installation and hook-up required.

There are 4 signal lines used in each channel. Each arrester input connector (P1, P2 and P3) has 16 pins for 16 signal lines so 4 channels are used in each connector. Each arrester has 3 input (and output) connectors, so a total of 12 channels, requiring 48 signal lines are provided by the arrester. Use of the arresters is normally deter-

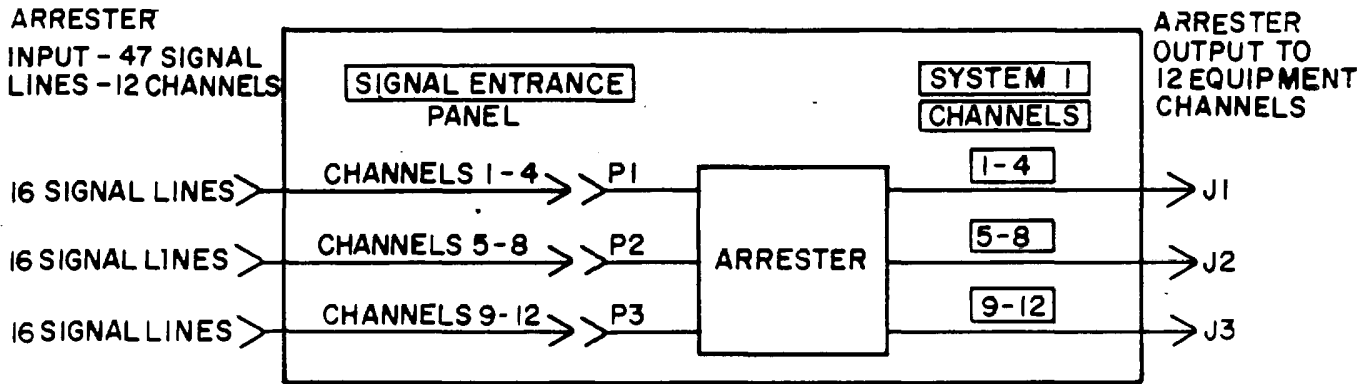

1-7. **CHARACTERISTICS**

There are no operating requirements for the arrester such as turn-on, settings or adjustments.

A minimum of maintenance is required. The arrester is used in locations where, for access, shelter equipment must be disassembled.

1-8. **LOCATION AND DESCRIPTION OF MAJOR COMPONENTS**

LOCATION

The location of the arrester is determined by the physical layout of the shelter in which it is used. Normally the arrester is mounted inside a SIGNAL ENTRANCE panel within a communications shelter. The shelter may have a SIGNAL ENTRANCE panel on the curbside, the roadside or both the curbside and roadside of the shelter. Refer to the shelter technical manual (TM) for arrester locations.

DESCRIPTION OF MAJOR COMPONENTS

The arrester has been described physically under the capabilities and features (para 1-6). For a detailed description of the arrester in its shelter-applied use refer to the shelter manual.

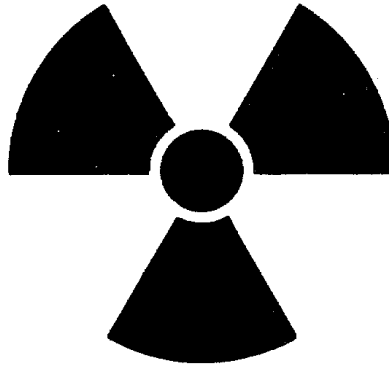
WARNING**RADIOACTIVE MATERIAL****1-9. SAFETY, CARE AND HANDLING****REASONS FOR WARNING**

Each arrester contains 24 spark gap components and each contains radioactive material. DO NOT ASSEMBLE THE ARRESTER FOR ANY REASON: Wear protective gloves when handling components which may have been in contact with a damaged arrester.

DAMAGED EQUIPMENT

WHEN AN ARRESTER IS DAMAGED AND INTERNAL COMPONENTS ARE EXPOSED DO NOT HANDLE: REFER DISPOSAL TO QUALIFIED PERSONNEL WHO ARE AUTHORIZED TO HANDLE RADIOACTIVE (NUCLEAR) MATERIAL

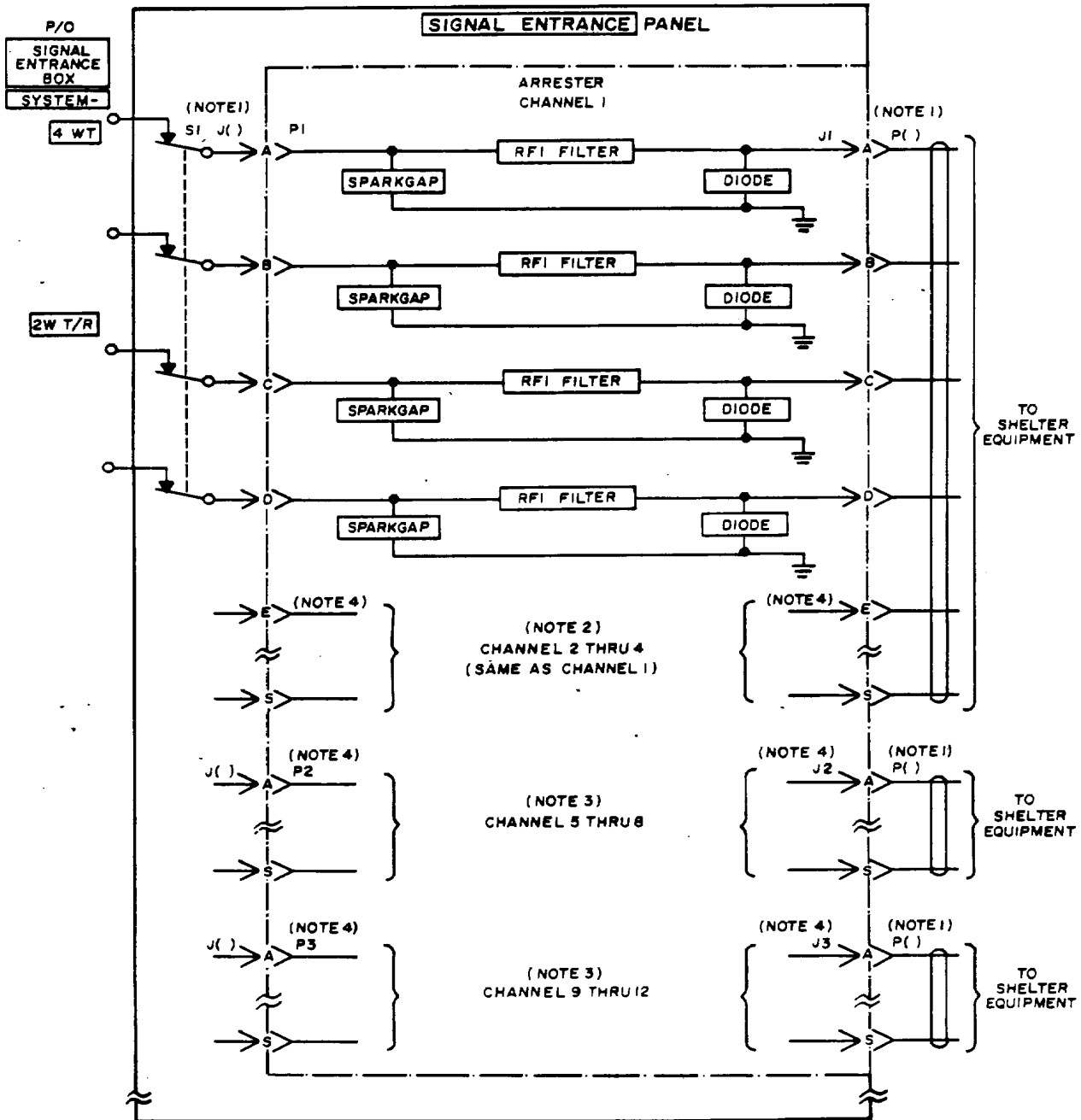

NOTES:

1. FOR INPUT J AND OUTPUT P, DESIGNATIONS REFER TO SHELTER CABLING DATA.
2. ALL CHANNEL CIRCUITS ARE THE SAME AS CHANNEL 1 THRU 4.
3. CHANNEL 5 THRU 8 AND 9 THRU 12, ARE THE SAME AS CHANNEL 1 THRU 4.
4. INPUT AND OUTPUT CONNECTOR PINS:
 CHANNEL 1,5,9 - A B C D
 CHANNEL 2, 6, 10 - J K L M
 CHANNEL 3, 7, 11 - E F G H
 CHANNEL 4, 8, 12 N P R S

5. SIGNAL ENTRANCE BOX BINDING POSTS.

SECTION III. PRINCIPLES OF OPERATION

Section Contents	Paragraph
Functional Description	1-10
Function of Arrester Parts.....	111

1-10. FUNCTIONAL DESCRIPTION

NOTE

What is shown is a typical use of the arrester. All CHANNEL circuits are the same. Only Channel 1 is shown. A system is the entire input and output of one arrester.

INPUT AND OUTPUT CIRCUITS

Each Input line is an unbalanced Input (with reference to ground or another zero reference point). Each arrester CHANNEL has four input lines and together form a balanced 4-wire Input CHANNEL. The Input signal arrives at the shelter SIGNAL ENTRANCE BOX. (As shown, the 4WT and 2WT/R are a type of binding post connector.) Switch S1 connects the Input signal to the arrester. Any unwanted high induced voltage arriving with the input signal would be removed or attenuated by the arrester. The output signals from the arrester J1, J2 and J3 connectors are applied to the shelter equipment.

1-11 FUNCTION OF ARRESTER PARTS

SPARK GAP

Each input line has a spark gap (ionizing tube) which contains radioactive material between its elements. The radioactive material within the spark gap will very quickly cause ionization to take place when an extremely high, rapidly rising voltage is present on the input line. The ionization places a low resistance through the spark gap to ground reducing the high induced line voltage to a low level. The high, rapidly rising voltage could be a high altitude nuclear explosion or lightning from electrical and thunderstorms.

RADIO FREQUENCY INTERFERENCE (RFI) FILTER

Input rf signals above the required frequency of the signal equipment will be attenuated (reduced in amplitude level). High rapidly rising Input voltages have an Inherent high frequency component which will be attenuated by the rfi filter.

DIODES

The diodes are two diodes with their cathodes connected together. With a given voltage polarity applied to the diodes, one will present a high resistance the other a low resistance. When an applied voltage exceeds about 170 volts, the high resistance diode will start to break down and conduct current through the low resistance diode. The diodes, together prevent the applied voltage from exceeding about 170 volts.

**CHAPTER 2
ORGANIZATIONAL MAINTENANCE
SECTION I. REPAIR PARTS, SPECIAL TOOLS,
TMDE AND SUPPORT EQUIPMENT**

Section Contents	Paragraph
Repair Parts	2-1
Common Tools and Equipment	2-2
Test, Measurement and Diagnostic Equipment (TMDE)	2-3
Test Equipment.....	2-4

2-1. REPAIR PARTS

Repair parts are listed and illustrated in Repair Parts and Special Tools List TM 11-5920-252.24P.

2-2. COMMON TOOLS AND EQUIPMENT

For additional authorized common tools and equipment refer to the Modified Table of Organization and Equipment (MTOE) applicable to your unit.

Organizational maintenance personnel will require tools contained in Tool Kit, Electronic' Equipment TK-101/G to service the arrester.

2-3. TMDE

There are no TMDE authorized for organizational maintenance personnel.

2-4. TEST EQUIPMENT

Organizational maintenance personnel are authorized to use Multimeter TS-352B/U.

**SECTION II. PREVENTIVE MAINTENANCE
CHECKS AND SERVICES (PMCS)**

Section Contents	Paragraph
Routine Services.....	2-5
PMCS Table	2-6

2.5. ROUTINE SERVICES

Routine services are a collection of checks and observations performed by organizational maintenance personnel at all times. Routine services are not listed in the preventive maintenance checks and services table in order to separate the nonoperational from the operational services.

Perform the following routines as necessary.

- Clean connectors to remove dust, dirt and condensation
- Check tightness of cable connectors
- Check for frayed or cut cables

WARNING

Adequate ventilation should be provided while using TRICHLOROTRI- FLUOROETHANE. Prolonged breathing of vapor should be avoided. The solvent should not be used near heat or open flame; the products of decomposition are toxic and irritating. Since TRICHLOROTRIFLUOROETHANE dissolves natural oils, prolonged contact with skin should be avoided. When necessary, use gloves which the solvent cannot penetrate. If the solvent is taken internally, consult a physician immediately.

2.6. PMCS TABLE

The arrester unit is not accessible for physical checks or services. PMCS of the communications equipment associated with the arrester will satisfy the PMCS of the arrester. Table 2-1 will provide a means to complete Form 2404, Equipment Inspection and Maintenance Worksheet.

TABLE 2.1. Preventive Maintenance Checks and Services

ITEM NO.	INTERVAL			ITEM TO BE INSPECTED PROCEDURE	Equipment is Not Ready/ Available If
	D	W	M		
1		x		<p>Communications systems which are routed through the arrester(s).</p> <p style="text-align: center;">NOTE</p> <p>When all communication systems are operated once during a week period PMCS of the arrester is considered accomplished.</p>	Communication system Inoperable due to arrester fault.

SECTION III. TROUBLESHOOTING

Section Contents	Paragraph
General	2-7
Tools and Test Equipment.....	2.8
Troubleshooting Procedure	29

2.7 GENERAL

Troubleshooting at the organizational maintenance level is limited to resistance measurements.

The arrester is a passive device, therefore the absence of a signal to a shelter communications equipment could be the fault of the arrester when it is certain that the signal is present at the input (channel) of the arrester.

Table 2-2 gives the typical channel numbers with the circuit over which signals pass through the arrester. For example, the 4 lines used for channel 1 are P1 to J1 pins A to A, B to B, C to C and D to D.

2-8. TOOLS AND TEST EQUIPMENT

A Phillips screwdriver located in Tool Kit, Electronic Equipment TK-101/G is required for access to the arrester.

Multimeter TS-352B8U is required to make the necessary resistance measurements.

2-9. TROUBLESHOOTING PROCEDURE

1. Determine the faulty channel.
2. Remove the access panel of the SIGNAL ENTRANCE panel. Determine from Table 2-2 which circuits may be at fault and disconnect P and J connectors of the arrester.
3. Perform continuity check as follows:
 - Set TS-352B/U FUNCTION switch to OHMS and set range switch to RX1.
 - Connect the TS-352BIU leads to the same lettered pins on the P and J connectors shown in Table 2-2.
 - All resistance measurements should be less than 20 ohms. If any measurement is more than 20 ohms, higher level of maintenance is required.

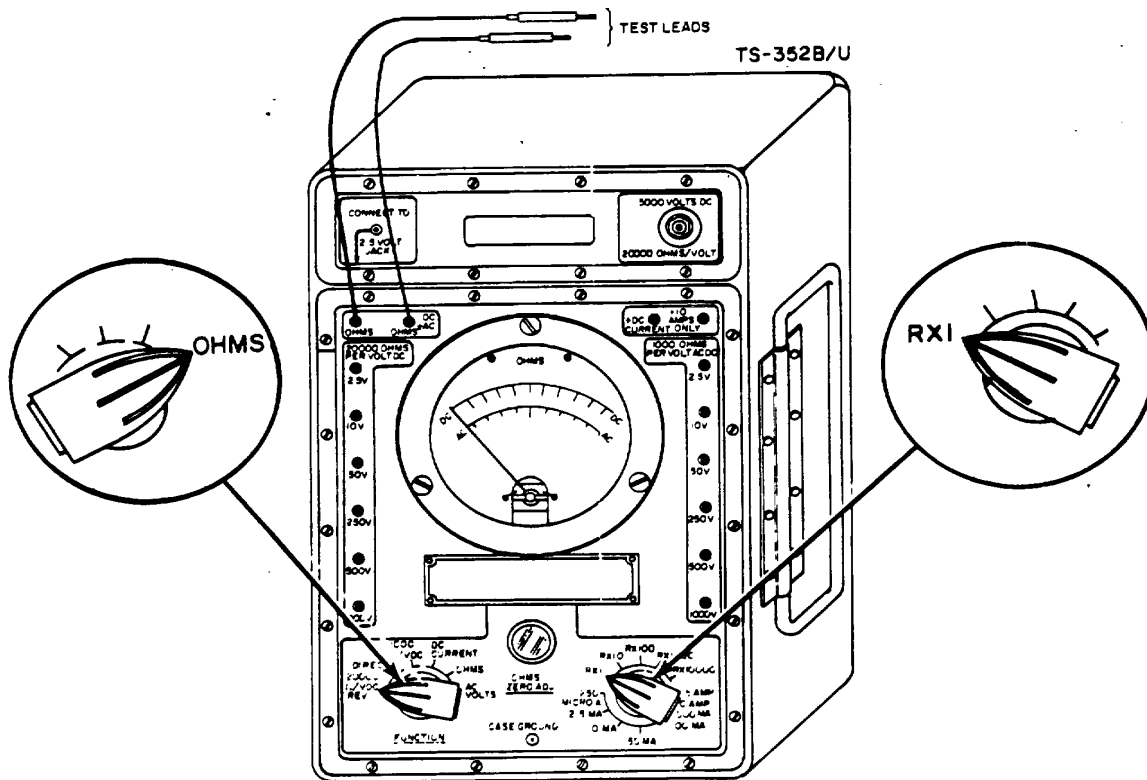
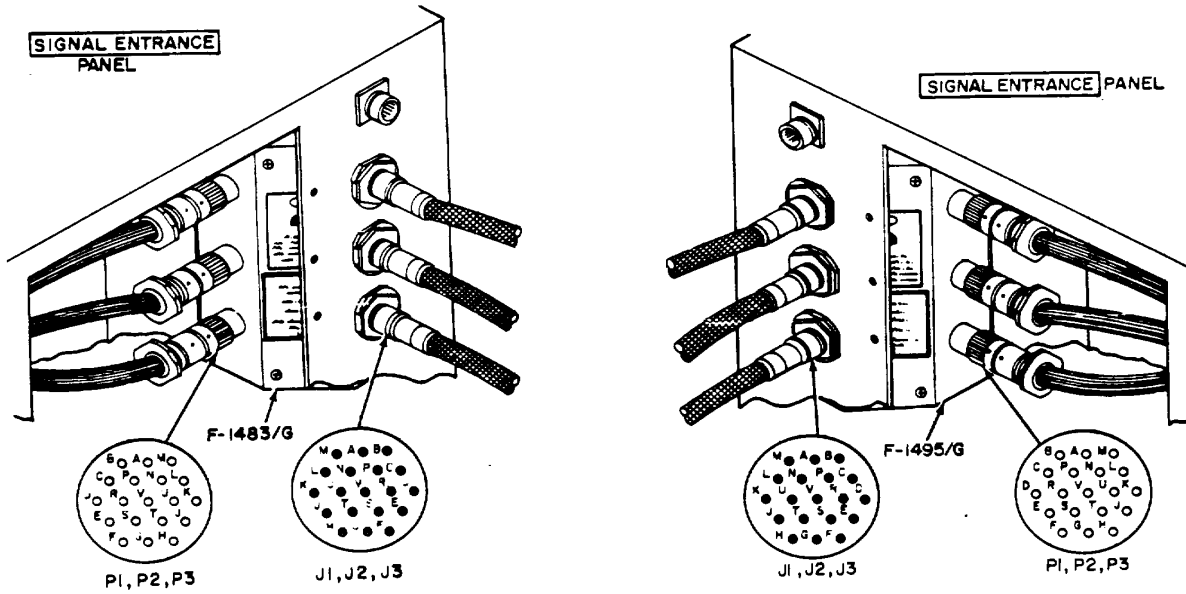

4. Perform short circuit test as follows:

- Set TS-352B/U FUNCTION switch to OHMS and set range switch to RX 10000

- Connect one lead of the TS-352B/U to ground. At the J connector connect the other TS-352B/U lead to each pin of the faulty channel. All resistance measurements should be more than 1 megohm (1,000,000 ohms). Reverse the TS-352BIU leads and repeat the resistance measurements. All measurements, again, should be more than 1 megohm. If any measurement is less than 1 megohm, higher level of maintenance is required.

TABLE 2.2. CONTINUITY CHART

Channel No.	Connectors	Connector pins			
1	J1-P1	A	B	C	D
2		J	K	L	M
3		E	F	G	H
4		N	P	R	S
5	J2-P2	A	B	C	D
6		J	K	L	M
7		E	F	G	H
8		N	P	R	S
9	J3P3	A	B	C	D
10		J'	K	L	M
11		E	F	G	H
12		N	P	R	S

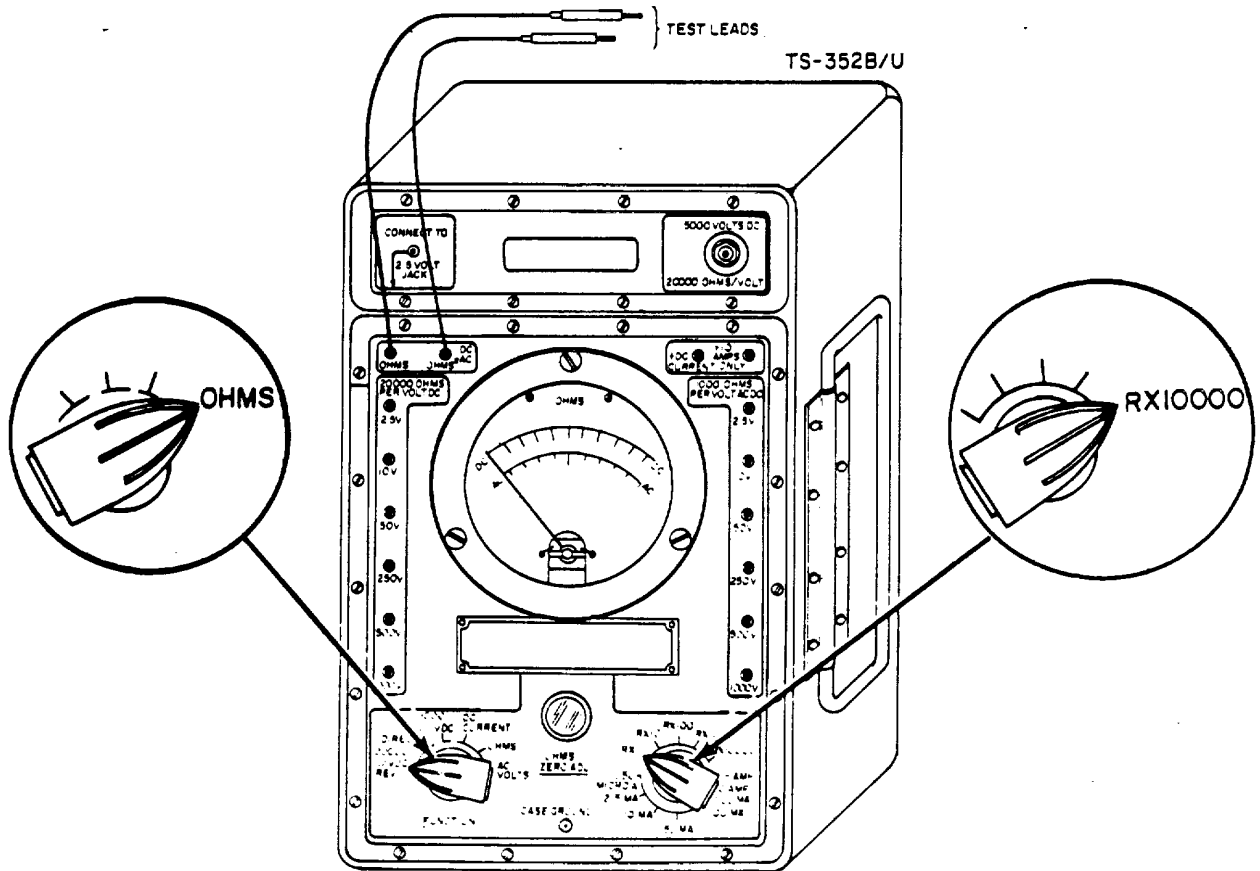
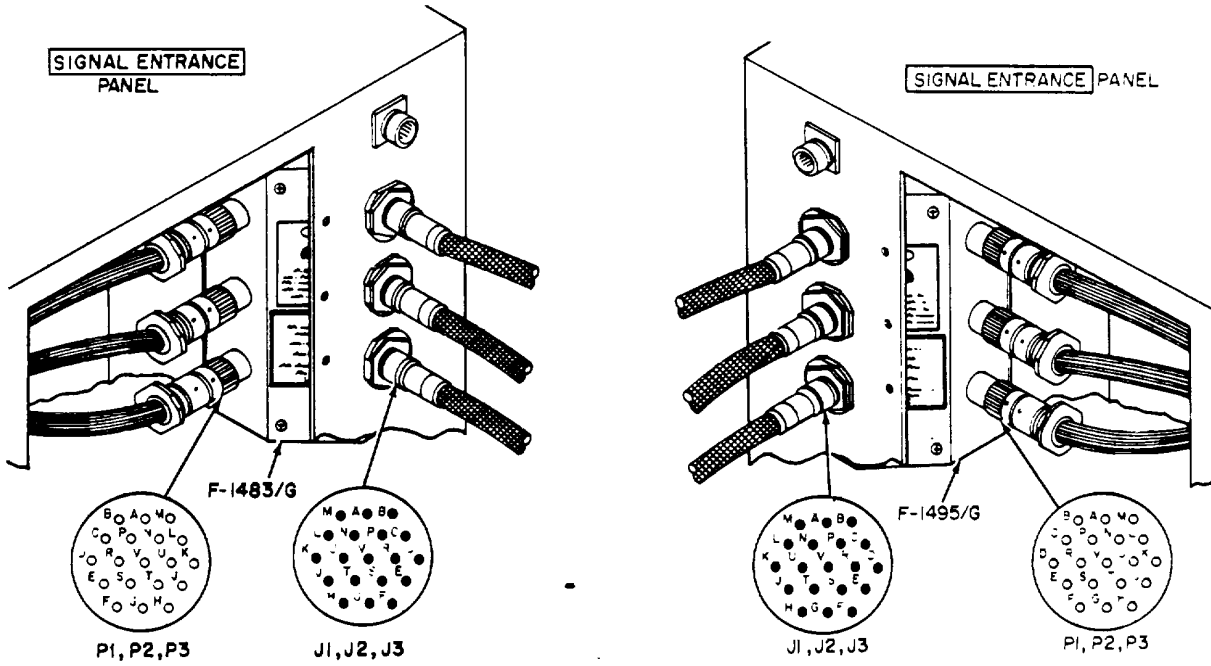

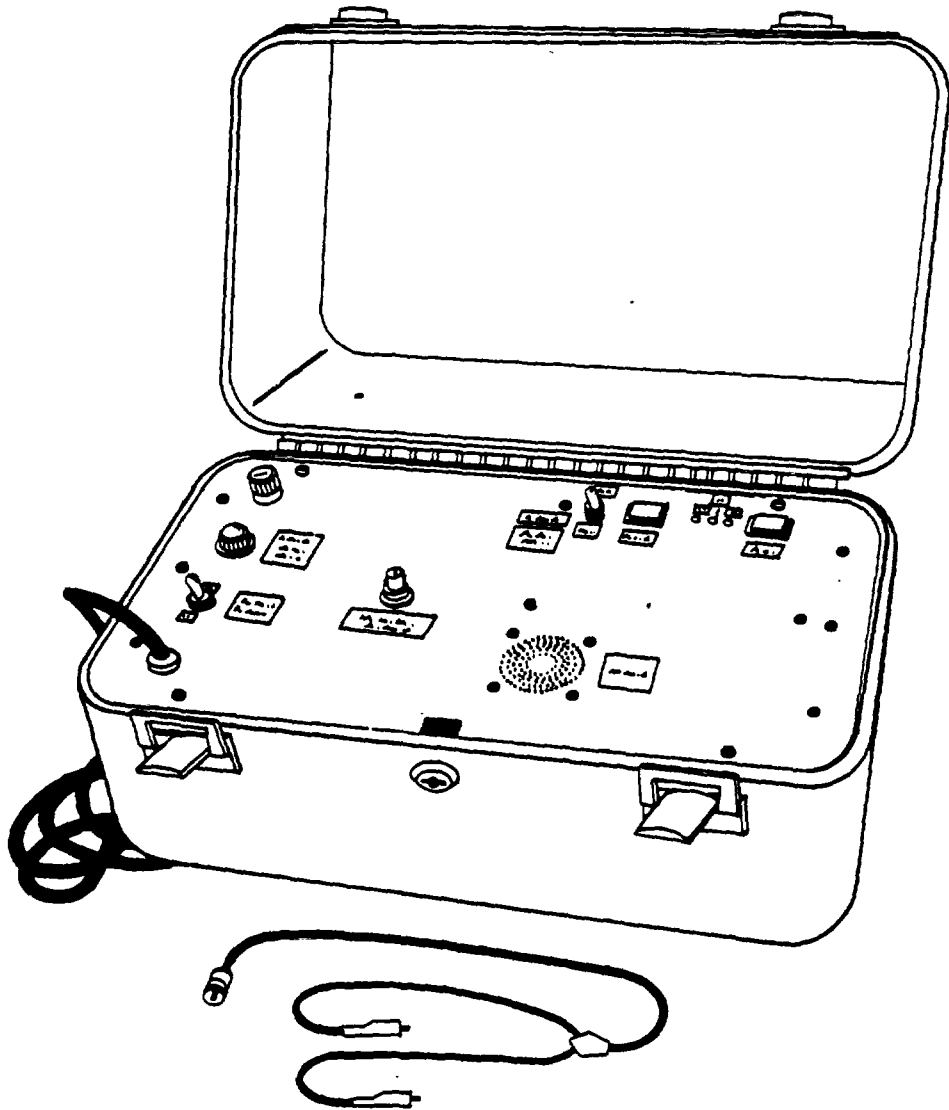

TS-3760/G

CHAPTER 3
DIRECT SUPPORT(DS) AND
GENERAL SUPPORT (GS) MAINTENANCE
SECTION I. REPAIR PARTS, SPECIAL TOOLS,
TMDE AND SUPPORT EQUIPMENT

Section Contents	Paragraph
Repair Parts.....	3-1
Common Tools and Equipment.....	3-2
Test, Measurement and Diagnostic Equipment (TMDE).....	3-3
Test Equipment.....	3-4

3-1. REPAIR PARTS

Repair parts are listed and illustrated in DMWR 11-5920-252.

3-2. COMMON TOOLS AND EQUIPMENT

For additional authorized common tools and equipment refer to the Modified Table of Organization and Equipment (MTOE) applicable to your unit.

Direct support (DS) and general support (GS) maintenance personnel will require tools contained in Tool Kit, Electronic Equipment TK-100/G.

3-3. TMDE

Test Set TS-3760/G will be used by DS and GS maintenance personnel to test and troubleshoot the arrester. The TS-37601G is a test set used only for the arrester.

3-4. TEST EQUIPMENT

Multimeter TS-352B/U will be used to make resistance measurements.

SECTION II. SERVICE UPON RECEIPT

Section Contents	Paragraph
Site and Shelter Requirements.....	5
Unpacking.....	3-6
Checking Unpacked Equipment	37

3-5. **SITE AND SHELTER REQUIREMENTS**

Each arrester is normally installed in a shelter in the typical location shown below. The curbside arrester (F-1495/G) is designed for the SIGNAL ENTRANCE panel on the shelter's curbside (right-hand side). The roadside arrester (F-1483/G) is designed for the SIGNAL ENTRANCE panel on the shelter's roadside (left-hand side). Although the F-1483/G and F-14951G arresters are electrically the same, each can only be properly mounted in the location the arrester was designed for.

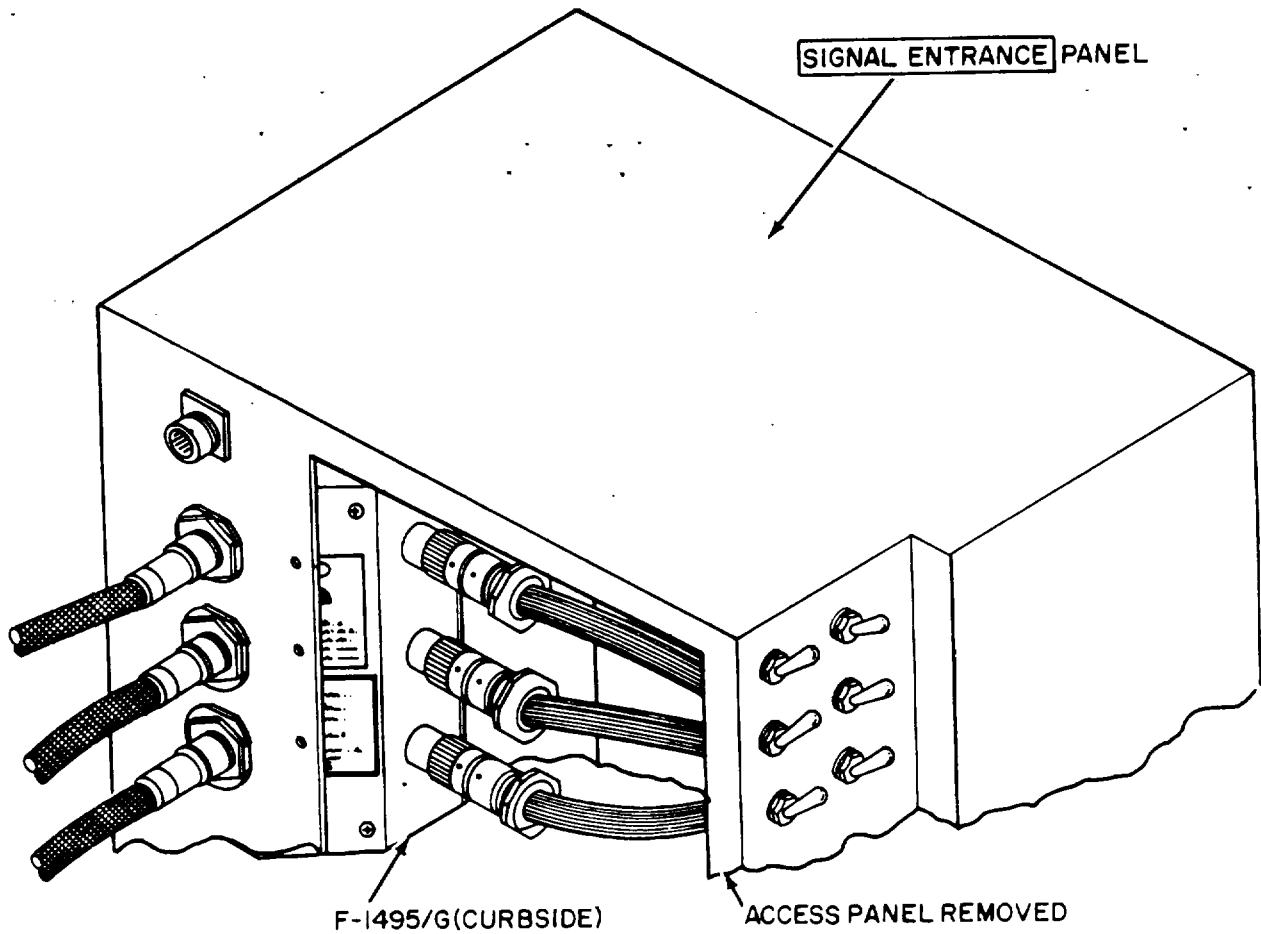

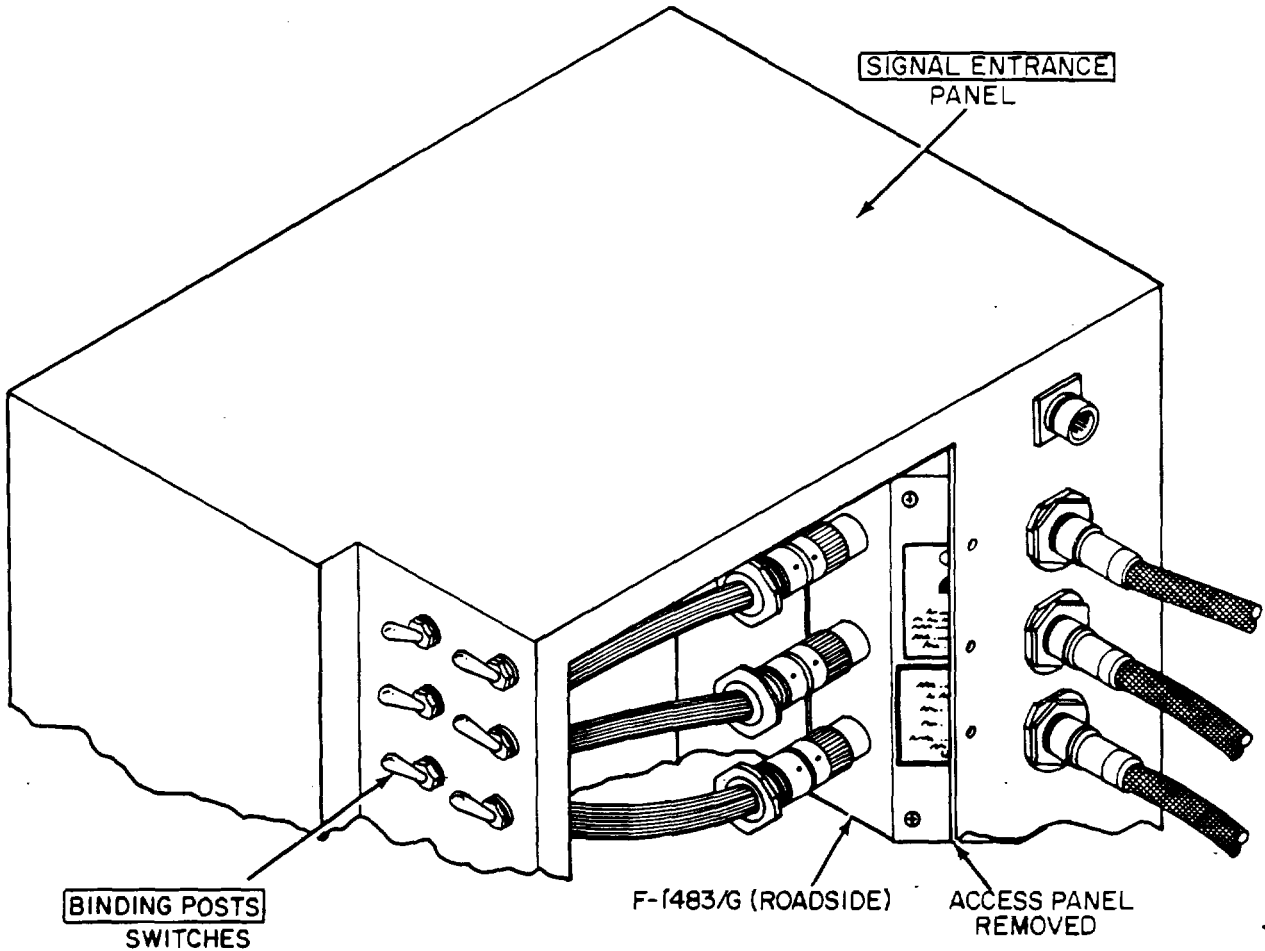

Refer to Do Pam 310-4 for the proper modification work order (MWO) to modify the shelter for installation of the arrester when required.

Refer to the shelter equipment (configuration) manual for cabling and other shelter requirements for this equipment that are not provided in this manual.

3.6. UNPACKING

Normally the arrester will be installed in a shelter. When an arrester is received for replacement or initial installation it will be received typically packaged as shown below.

3-7. CHECKING UNPACKED EQUIPMENT

Inspect the equipment for damage incurred during shipment. If the equipment has been damaged, report the damage on SF 364 (Report of Discrepancy (ROD)) as prescribed in AR 735-11-2/DLAR 4140-55/ NAVMATINST 4355.73/AFR 400-54/MCO 4430.3E.

Check the equipment against the packing slip to see if the shipment is complete. Report all discrepancies in accordance with the instructions of TM 3&750.

Check to see whether the equipment has been modified.

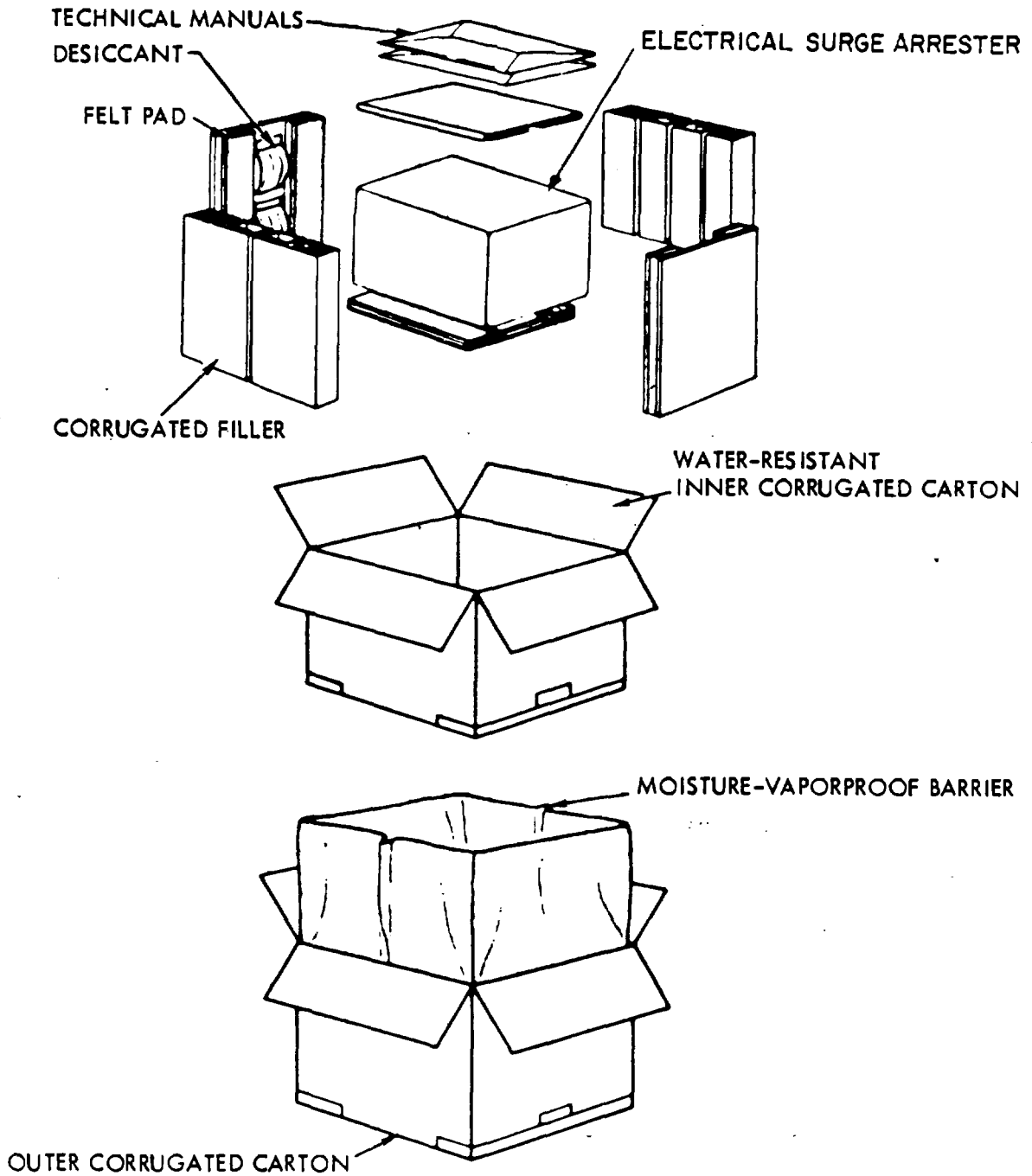

SECTION III. INSTALLATION

Section Contents	Paragraph
General	3-8
Tools Required	3-9
Installation Procedure	10
Cabling.....	11

3-8. GENERAL

Verify that the shelter has the requirements for the arrester. Refer to Site and Shelter Requirements (para 3-5).

3.9. TOOLS REQUIRED

A No. 2 Phillips screwdriver and a crescent wrench are the tools required. These tools are in Tool Kit, Electronic Equipment TK-100/G.

3-10. INSTALLATION PROCEDURE

1. Turn off all the shelter communications equipment. The turn off procedures can be found in the shelter configuration maintenance manual. Refer to DA Pam 310-4 to obtain the technical manual (CM) number.
2. Disconnect the cable connectors from J1, J2, and J3. They are usually labeled CHANNEL 1-4, 5-8, and 9-12.

NOTE

When more than 12 channels are used in the shelter an additional arrester will be needed. Installation procedures for each arrester are the same.

3. Remove the SIGNAL ENTRANCE panel access panel with the Phillips screwdriver. Retain the access panel and screws.
4. Remove and discard the three connector retaining nuts holding connectors J1, J2 and J3 to the SIGNAL ENTRANCE Panel.

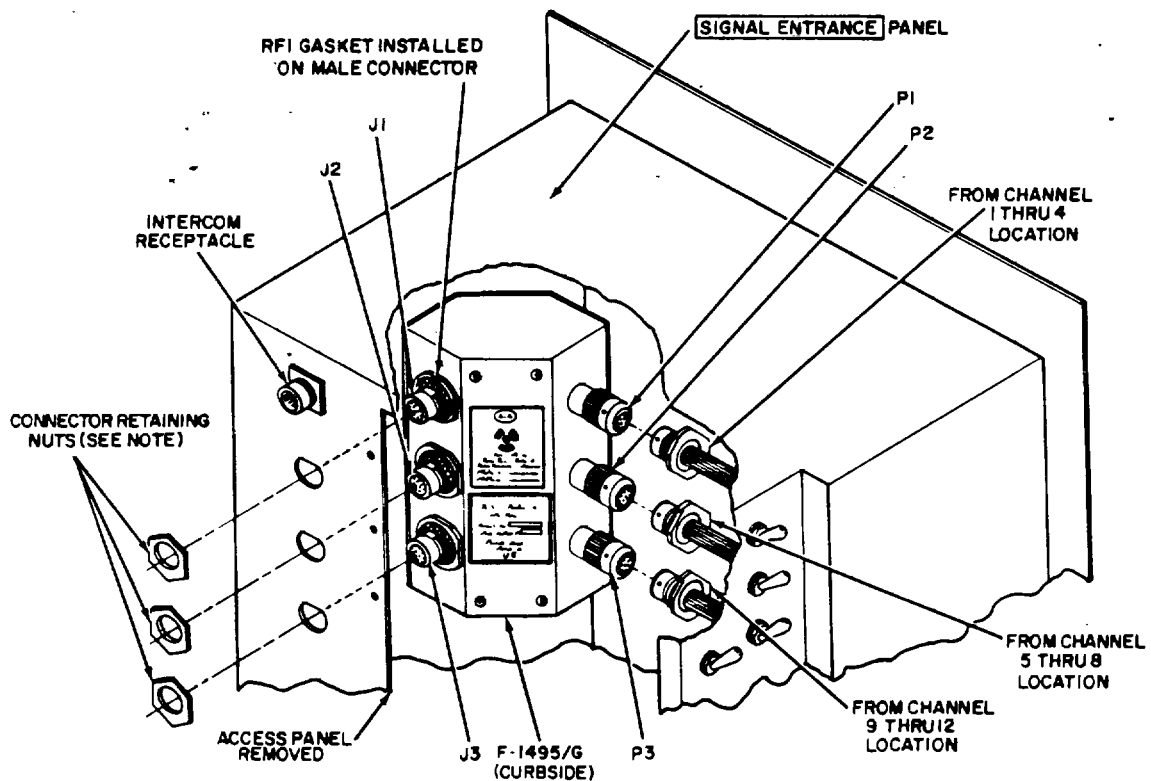

NOTE:
CONNECTOR RETAINING NUTS FURNISHED WITH ARRESTER.

5. Remove and label the connectors J1, J2 and J3.
6. Before installation, remove the three connector retaining nuts from the J connectors of the arrester.
7. From the inside of the SIGNAL ENTRANCE panel, place the arrester J1, J2 and J3 connectors through the SIGNAL ENTRANCE panel holes. Be certain that the washer-shaped metal fiber RFI gaskets are in place on the three arrester J connectors.

NOTE

The arrester connectors and the panel holes will be flattened on the top. If they do not match, do not force into place or install the arrester upside down.

8. Install and tighten the connector retaining nuts on connectors J1, J2 and J3.

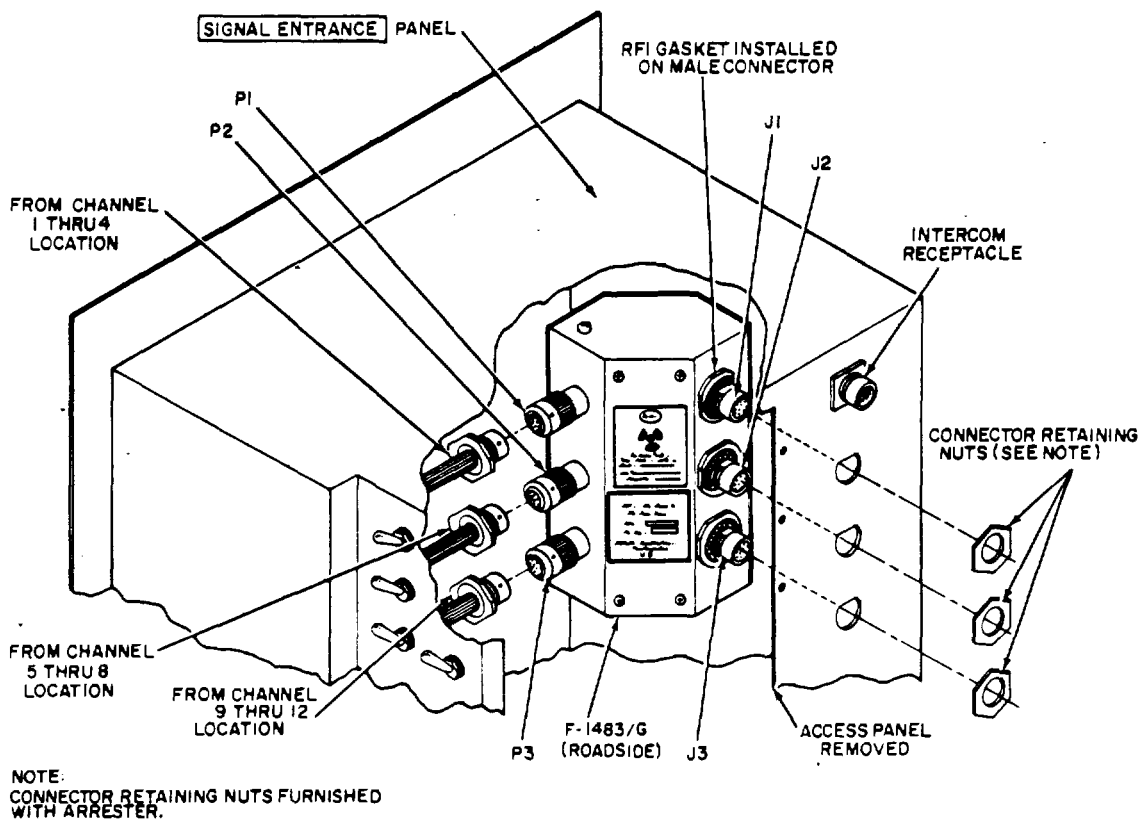

NOTE:
CONNECTOR RETAINING NUTS FURNISHED WITH ARRESTER.

3-11. CABLING

Inside the SIGNAL ENTRANCE panel connect the J1, J2 and J3 connectors to the P1, P2 and P3 connectors of the arresters.

Install the SIGNAL ENTRANCE panel access panel.

Reconnect the three connectors from the shelter communications equipment that were connected to the CHANNEL 1-4, 58 and 9-12 connectors on the SIGNAL ENTRANCE panel.

SECTION IV. TESTING

Section Contents	Paragraph
General	3-12
Test Equipment	3-13
Testing Procedure	3.14
Test Set TS.3760/G In AUTO Mode	3-15

3-12. **GENERAL**

After the arrester has been installed, testing of the arrester is done from the SIGNAL ENTRANCE box which is located outside the shelter.

After the arrester has been installed, each communications system input line (circuit) is checked to insure that the arrester will perform its function.

Normally each communication system will use 4 input lines (circuits). Therefore to check an arrester, 48 circuits within the arrester will be checked for proper operation.

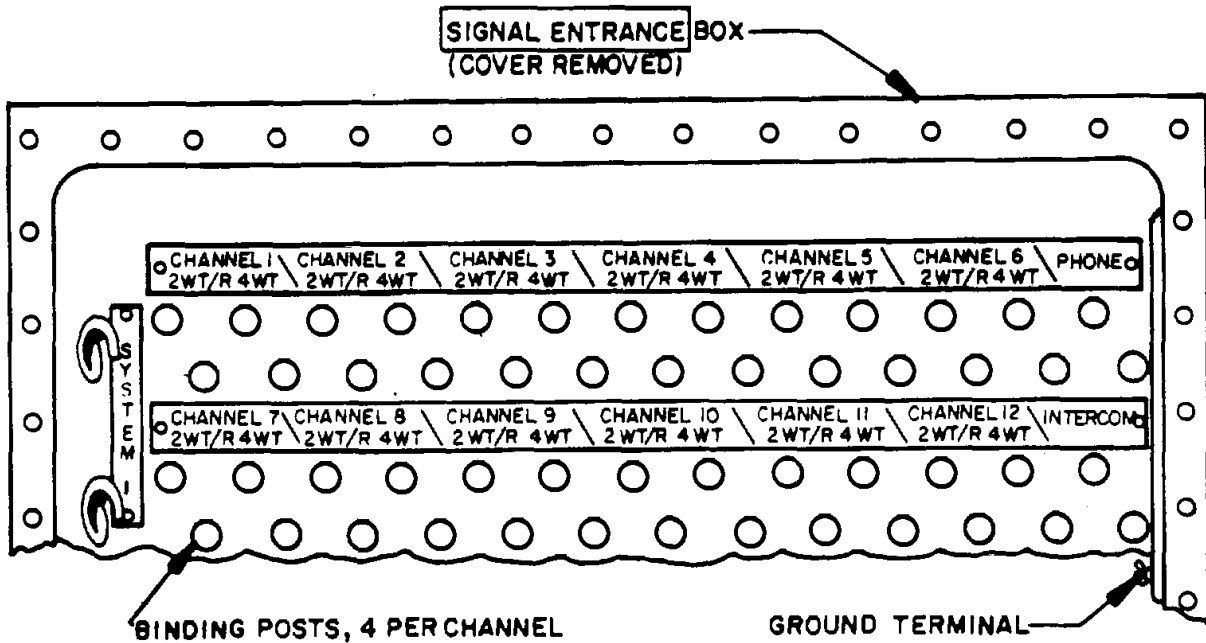

3-13. TEST EQUIPMENT

Test Set TS-37601G is a test set for only the arrester. The TS-37601G will check the arrester for the following:

- The spark gap (SG) which protects the communications equipment from extremely high energy sources such as lightning and nuclear explosions.
- A protective device called TRANSORB (TZ) is contained on each input circuit. The transorb will block line voltages above plus or minus 140 volts from the communications equipment.
- The test set will detect a short circuit within the arrester or Input circuit associated with the arrester.
- The test set will detect an open circuit within the arrester or Input circuit

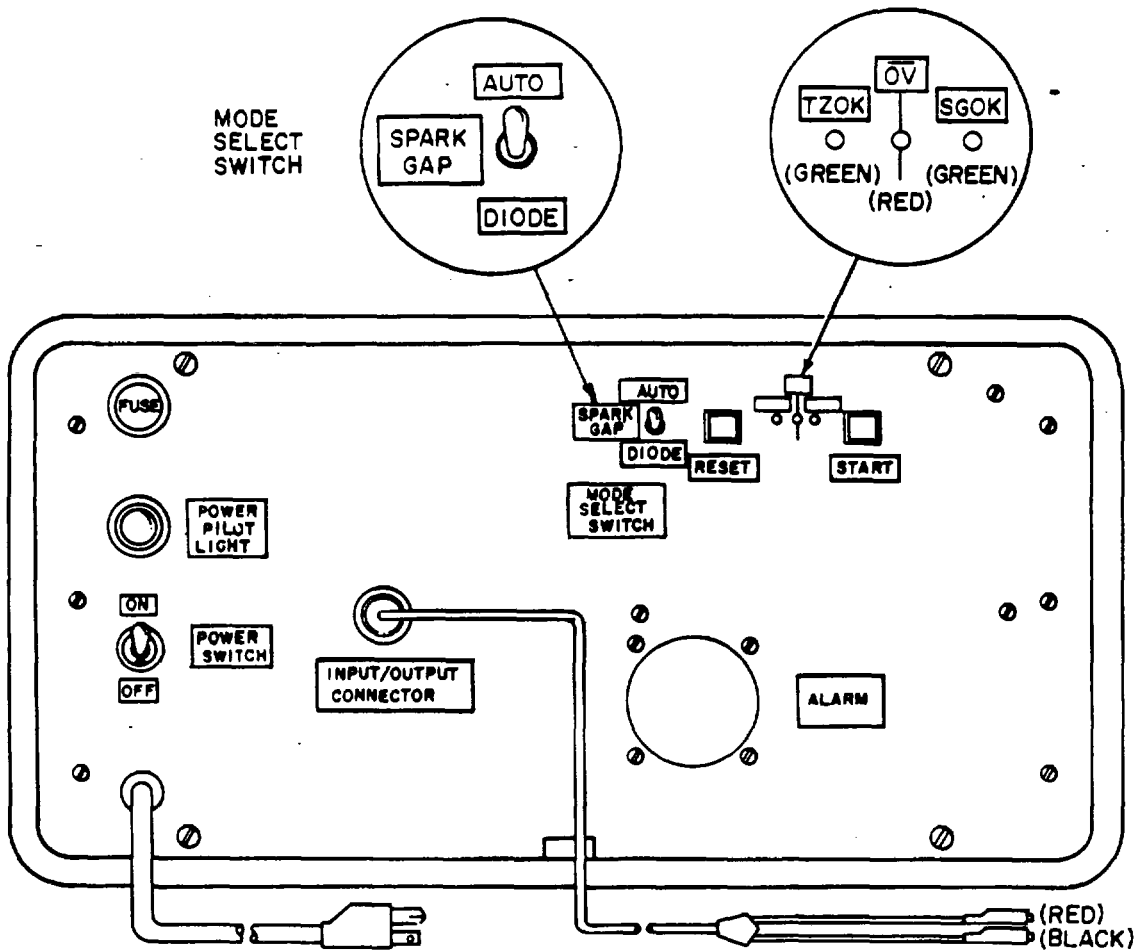

NOTE

Test Set TS-3760/G requires 105 to 125-volt 50 to 400 Hz power for operation. Refer to the shelter technical manual to determine the location of the power source. Refer to DA Pam 310-4 for the technical manual (TM) number.

3.14. TESTING PROCEDURE

1. At the SIGNAL ENTRANCE panel, within the shelter, place all the CHANNEL switches to the BINDING POST position (up).

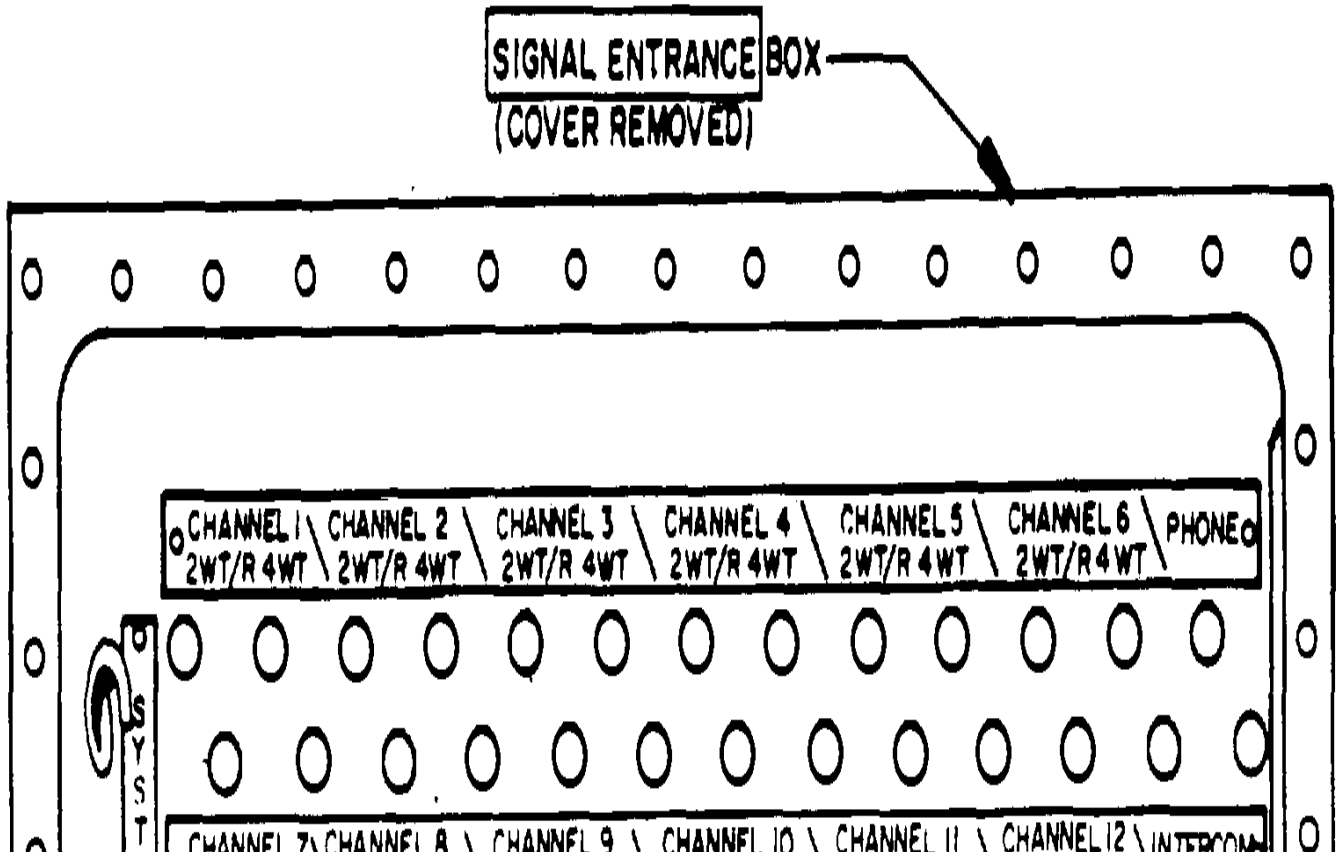

2. Place the TS-3760/G near the SIGNAL ENTRANCE box outside the shelter so that the test lead can reach all of the binding posts within the SIGNAL ENTRANCE box.

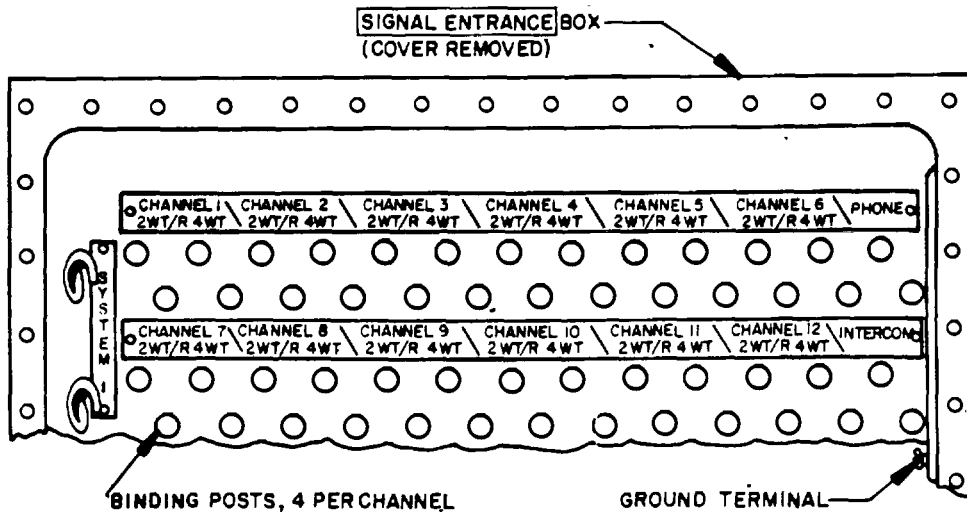

3. Preliminary conditions for the TS-37601G:

- POWER SWITCH OFF
- Test leads connected to the TS-37601G
- TS-3760/G MODE SELECT SWITCH to AUTO position (up)
- Connect TS-3760/G to the source of ac power

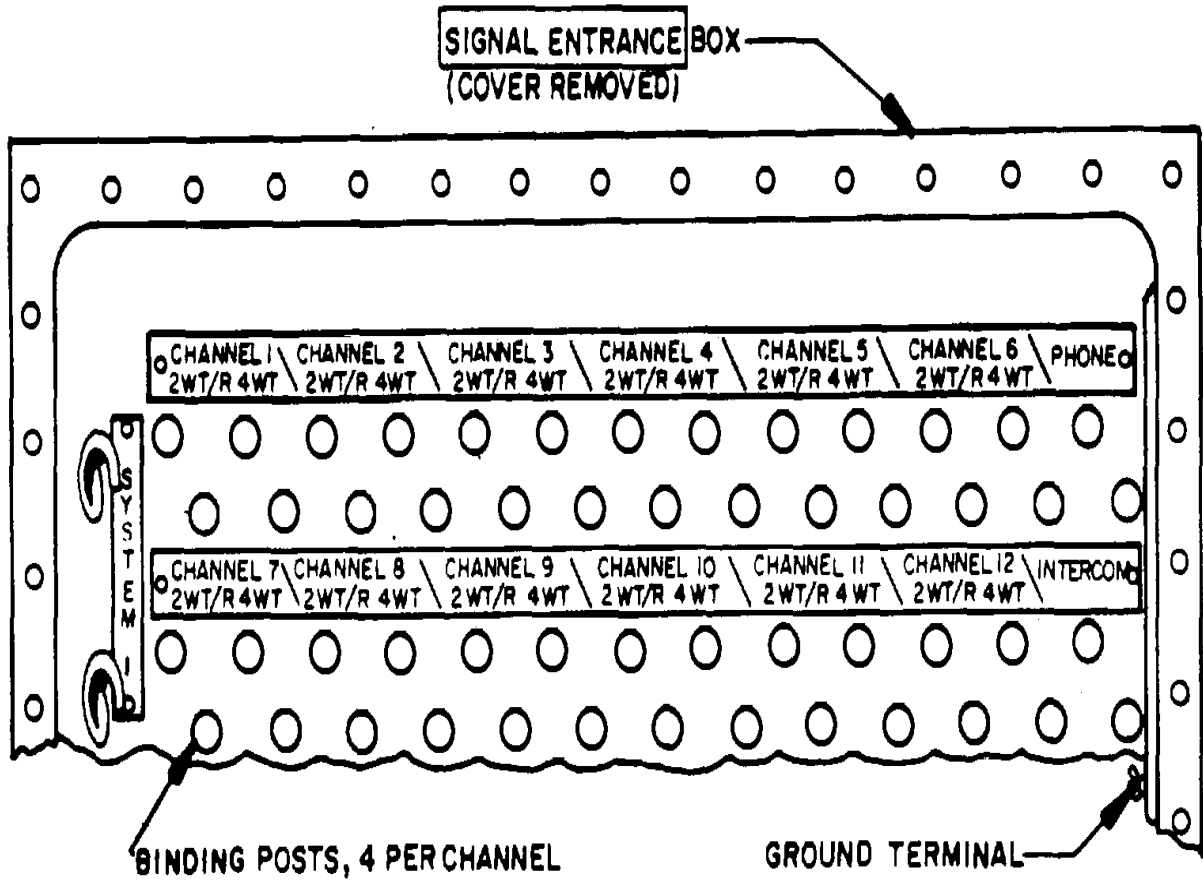

ARRESTER CIRCUIT TESTING

1. Connect the TS-37601G black test lead to a ground terminal within the SIGNAL ENTRANCE box. The ground terminal will be a wingnut or a binding post labeled GND (ground).

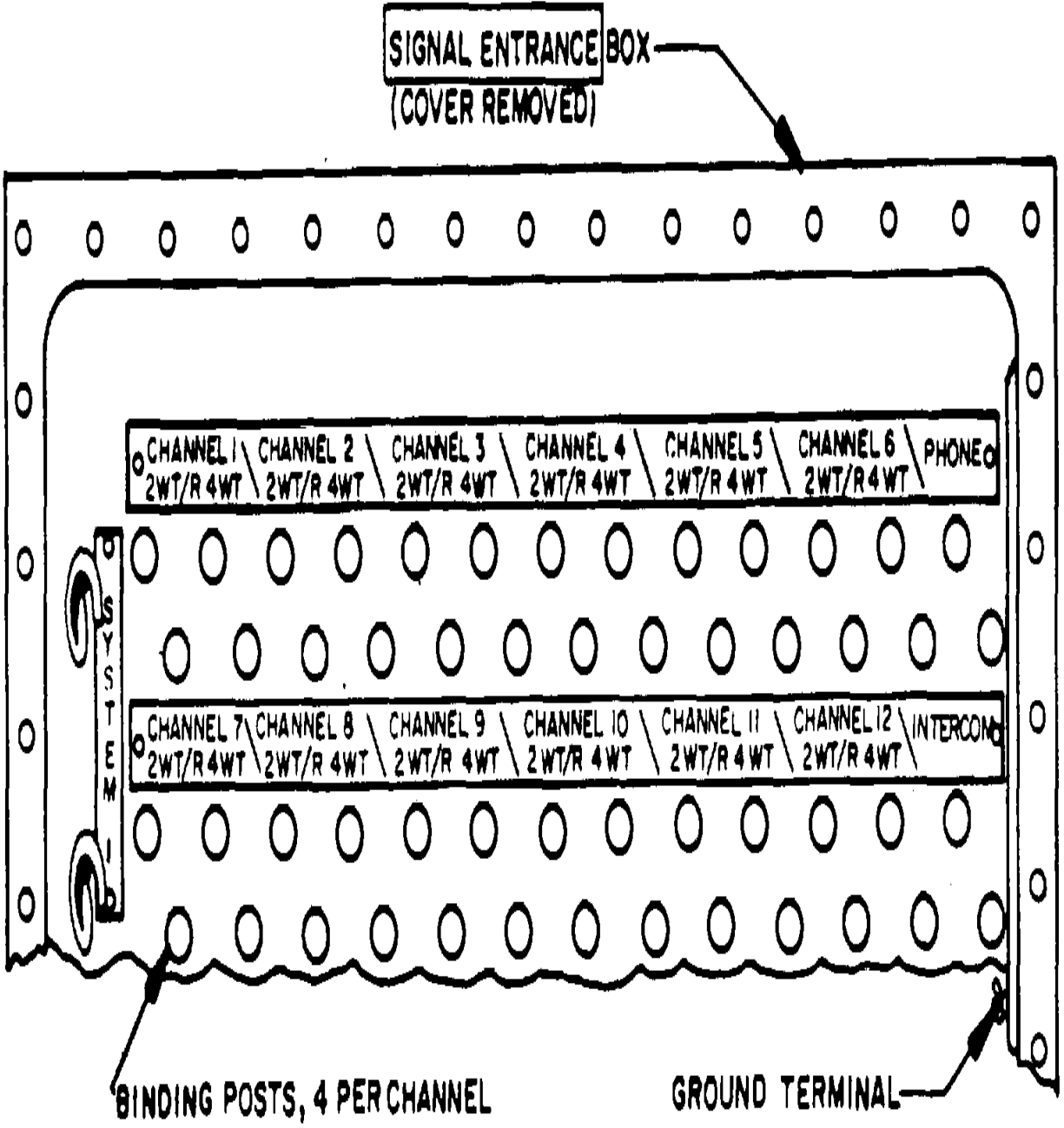

2. Steps 2 through 4 In Table 3-1 are to be performed at each of the 4 binding posts for channels 1 through 12. Step 1 will verify that the TS-3760/G is operable.

3.15. **TEST SET S-3760/G IN AUTO MODE**

TABLE 3-1. TS-3760/G AUTO (Automatic) Mode

Step	TS-3780/G Procedure	TS-3760/G Indication	Status/Condition
1	POWER SWITCH ON	Red OV light on if audible sound heard press RESET switch.	TS3760/G ok
2	Red test lead to binding post for CHANNEL 1	<ol style="list-style-type: none"> a. Green TZOK light on. Red OV light off. b. Audible tone from speaker. Red light on. 	<ol style="list-style-type: none"> a. Go to step 3. b. Possible faulty arrester.
3	Press START switch	<ol style="list-style-type: none"> a. Green SGOK light on. b. Audible garble sound from speaker and green SGOK light off. 	<ol style="list-style-type: none"> a. Go to step 4. b. Possible faulty arrester.
4	Connect red test lead to another binding post.	<ol style="list-style-type: none"> a. Same as step 2a above. above for all input lines of the arrester. b. Same as step 2b above. 	<ol style="list-style-type: none"> a. Repeat step.2 and 3 b. Same as step 2b above.

SECTION V. TROUBLESHOOTING

Section Contents	Paragraph
General	3-16
Test Equipment	3-13
Troubleshooting.....	3-18
Test Set TS.3760/G In Diode Mode	3-19
Test Set TS-3760/G In Spark Gap Mode	3-20
Removal and Replacement.....	3-21

3-16. GENERAL

When it has been determined that the arrester has a faulty circuit, the arrester is removed and replaced with another arrester. Repair of the arrester requires a higher level of maintenance.

Troubleshooting the arrester is necessary when:

- A communications channel within the shelter is inoperable because of the absence of the channel's Input signal, communications systems control, or communications system's output signal from the shelter.
- An arrester circuit does not check ok during the test' performed in Section IV, Table 3-1.

3-17. TEST EQUIPMENT

The following test equipment(s) are required for troubleshooting the arrester.

- Multimeter TS-352B/U
- Test Set TS-3760/G

3-18. **TROUBLESHOOTING**

USE OF TABLE 3-2

Table 3-2 will Indicate which circuits require further tests to Isolate the possible fault.

Test Set TS-3760/G set up:

- Ac power applied.
- MODE SELECT SWITCH in AUTO position.
- POWER SWITCH ON.
- Test leads connected in turn to circuits of faulty channel.
- Push START switch.
- Refer to Table 3-2 for indication.
- Push RESET switch upon completion of each circuit test.

TABLE 3.2. TROUBLESHOOTING

Symptom No.	Symptom	Procedure	Corrective Action
1	Faulty communications channel.	Perform steps 1 through 4 of table 3-1.	Refer to Symptoms No. 2 and No. 3 below.
2	TS-37601G red light	a. Refer to table 3-3 Condition column No. 1. b. Refer to table 3-3 Condition column No. 3.	a. Check cabling and wiring of input and output circuits of the arrester faulty line. b. Replace arrester.
3	TS-3760/G SGOK light off and garble sound heard.	Refer to table 3-4 Condition column No. 2.	Replace arrester.

3.19. TEST SET TS-3760/G IN DIODE MODE

USE OF TABLE 3-3

Table 3-3 gives the 3 possible TS-37601G indicator conditions for the transorb (back-to-back diodes) unit in the circuit being tested.

Test Set TS-3760/G set up:

- Ac power applied.
- MODE SELECT SWITCH in DIODE (down) position.
- Test lead connected (black to ground, red to circuit being tested).
- POWER SWITCH ON.
- Push START switch to begin test.
- Push RESET switch to stop ALARM (tone or garble sound).
- Push RESET upon completion of each circuit test.

TABLE 3-3. TRANSORB (TZ) TEST

Condition No.	OV Indicator (Red Light)	TK OK Indicator (Green Light)	Alarm Sound	Circuit Status
1	On	Off	Tone	Fail
2	Off	On	None	Pass
3	Off	Off	Garble	Fail

3.20. TEST SET TS-37601G IN SPARK GAP MODE

USE OF TABLE 3-4

Table 3-4 gives the 2 possible TS-3760/G indicator conditions for the spark gap unit in the circuit being tested.

Test Set TS-31601G set up:

- Ac power applied.
- MODE SELECT SWITCH in SPARK GAP (center) position.
- Test leads connected (black to ground, red to circuit being tested).
- Push START switch to begin test.
- Push RESET to stop ALARM (garble sound).
- Push RESET upon completion of each circuit test.

TABLE 3-4. SPARK GAP (SG) TEST

Condition No.	SG OK Indicator (Green light)	Alarm Sound	Circuit Status
1	On	None	Pass
2	Off	Garble	Fail

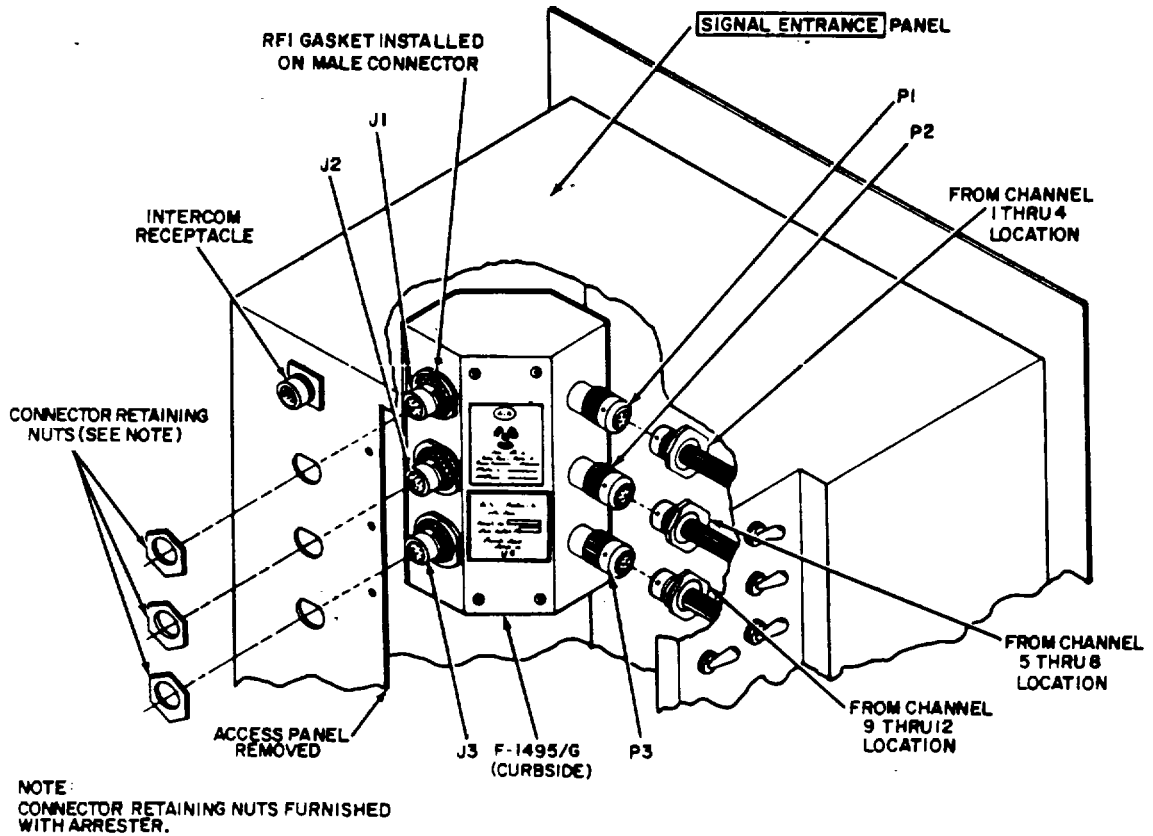
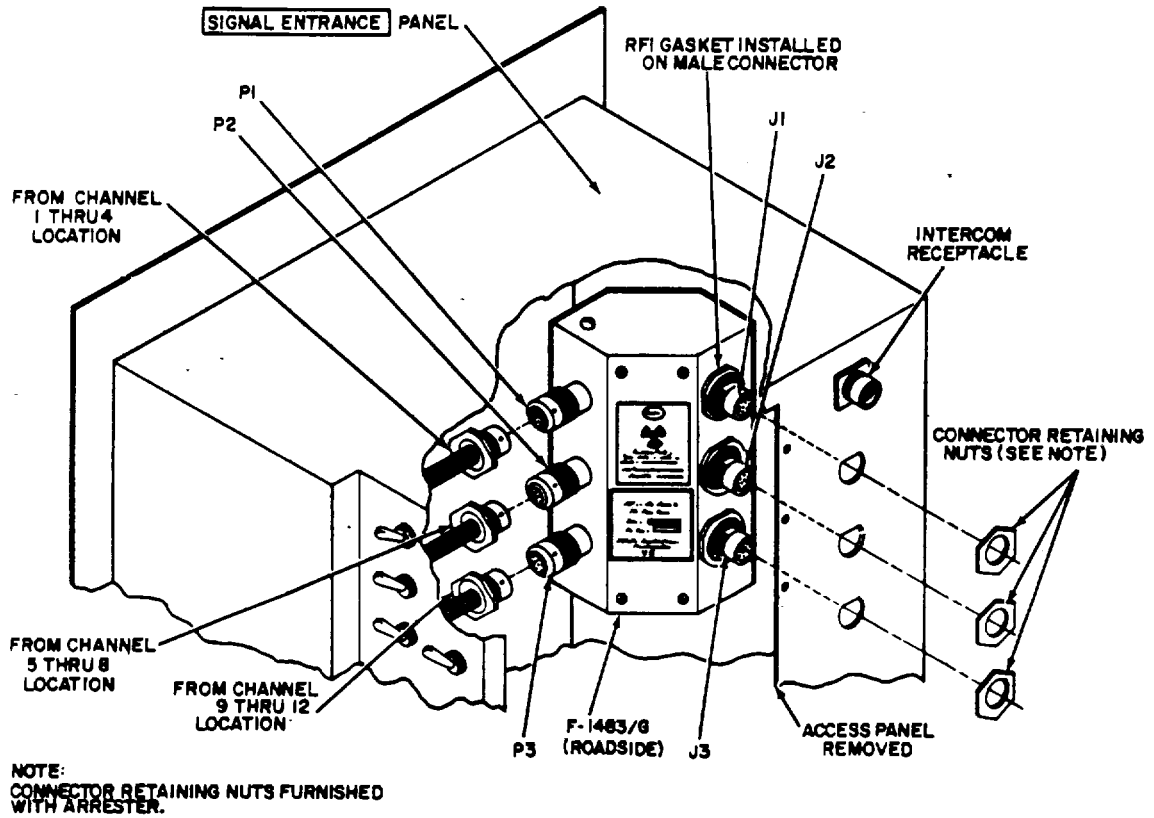

3-21. REMOVAL AND REPLACEMENT**REMOVAL**

1. Turn off power to all communications equipment located in the shelter.
2. Disconnect the SIGNAL ENTRANCE panel connectors connected to the arrester's connectors J1, J2 and J3.
3. Remove the SIGNAL ENTRANCE panel access panel by removing and retaining the access panel screws.
4. Inside the SIGNAL ENTRANCE panel, disconnect the connectors to the arrester's connectors P1, P2, and P3
5. On the outside of the SIGNAL ENTRANCE panel, remove the connector retaining nuts on connectors J1, J2 and J3.
6. Remove the arrester.

REPLACEMENT

1. Remove the three connector retaining nuts from the J connectors of the replacement arrester.
2. From the Inside of the SIGNAL ENTRANCE panel, place the arrester J1, J2 and J3 connectors through the SIGNAL ENTRANCE panel holes. Be certain that the washer-shaped metal fiber RFI gaskets are in place on the three arrester J connectors.

NOTE

The arrester connectors and the panel holes will be flattened on the top. If they do not match, do not force into place or Install the arrester upside down.

3. Install and tighten the connector retaining nuts on connectors J1, J2 and J3.
4. Inside the SIGNAL ENTRANCE panel connect the J1, J2 and J3 connectors to the P1, P2 and P3 connectors of the arrester.
5. Reinstall the SIGNAL ENTRANCE panel access panel.
6. Reconnect the three connectors from the shelter communications equipment that were connected to the CHANNEL 1-4, 5-8 and 9-12.

APPENDIX A

REFERENCES

AR 385-11	Ionizing Radiation Protection (Licensing, Control, Transportation, Disposal, and Radiation Safety).
OA PAM 310-4	Index of Technical Publications.
SB 38-100	Preservation, Packaging, Packing and Marking Materials, Supplies and Equipment Used by the Army.
TB 43-0116	Identification of Radioactive Items in the Army Supply System.
TM 43-0118	Field Instructions for Painting and Preserving Electronics Command Equipment and Camouflage Pattern Painting of Electrical Equipment Shelters.
TB 43-0122	Instructions for Safe Handling and Identification of the US Army Electronics Command Managed Radioactive Items in the Army Supply System.
TM 11-6625-366-10	Operator's Manual for Multimeter TS-352BIU (NSN 6625-00-553-0142).
TM 11-6625-366-15	Organizational, Direct Support, General Support, and Depot Maintenance Manual: Multimeter TS-352B/U (NSN 6625-00-553-0142).
TM 11-6625-366-24P	Organizational, Direct Support, and General Support Maintenance Repair Parts and Special Tools Lists (Including Depot Maintenance Repair Parts and Special Tools) for Multimeter TS-352B/U (NSN 6625-00-553-0142).
TM 38-750	The Army Maintenance Management System (TAMMS).
TM 740-90-1	Administrative Storage of Equipment.

A-1/(A-2 blank)

APPENDIX D
MAINTENANCE ALLOCATION

SECTION I. INTRODUCTION

D-1. General

This appendix provides a summary of the maintenance operations for F-1483/G and F-14951G. It authorizes categories of maintenance for specific maintenance functions on repairable items and components and the tools and test equipment required to perform each function. This appendix may be used as an aid in planning maintenance operations.

D-2. Maintenance Function

Maintenance functions will be limited to and defined as follows:

a. Inspect. To determine the serviceability of an item by comparing its physical, mechanical, and/or electrical characteristics with established standards through examination.

b. Test. To verify serviceability and to detect incipient failure by measuring the mechanical or electrical characteristics of an item and comparing those characteristics with prescribed standards.

c. Service. Operations required periodically to keep an item in proper operating condition, i.e., to clean (decontaminate), to preserve, to drain, to paint, or to replenish fuel, lubricants, hydraulic fluids, or compressed air supplies.

d. Adjust. To maintain, within prescribed limits, by bringing into proper or exact position, or by setting the operating characteristics to the specified parameters.

e. Align. To adjust specified variable elements of an item to bring about optimum or desired performance.

f. Calibrate. To determine and cause corrections to be made or to be adjusted on instruments or test measuring and diagnostic equipment used in precision measurement. Consists of comparisons of two instruments, one of which is a certified standard of known accuracy, to detect and adjust any discrepancy in the accuracy of the instrument being compared.

g. Install. The act of emplacing, seating, or fixing into position an item, part, module (component or assembly) in a manner to allow the proper functioning of the equipment or system.

h. Replace. The act of substituting a serviceable like type part, subassembly, or module (component or assembly) for an unserviceable counterpart.

i. Repair. The application of maintenance services (inspect, test, service, adjust, align, calibrate, replace) or other maintenance actions (welding, grinding, riveting, straightening, facing, re-machining, or resurfacing) to restore serviceability to an item by correcting specific damage, fault, malfunction, or failure in a part, subassembly, module (component or assembly), end item, or system.

j. Overhaul. That maintenance effort (service/action) necessary to restore an item to a completely serviceable/operational condition as prescribed by maintenance standards (i.e., DMWR) in appropriate technical publications. Overhaul is normally the highest degree of maintenance performed by the Army. Overhaul does not normally return an item to like new condition.

k. Rebuild. Consists of those services/actions necessary for the restoration of unserviceable equipment to a like new condition in accordance with original manufacturing standards. Rebuild is the highest degree of material maintenance applied to Army equipment. The rebuild operation includes the act of returning to zero those age measurements (hours, miles, etc.) considered in classifying Army equipment/components.

D-3. Column Entries

a. Column 1, Group Number. Column 1 lists group numbers, the purpose of which is to identify components, assemblies, subassemblies, and modules with the next higher assembly.

b. Column 2, Component/Assembly. Column 2 contains the noun names of components, assemblies, subassemblies, and modules for which maintenance is authorized.

c. Column 3, Maintenance Functions. Column 3 lists the functions to be performed on the items listed in column 2. When items are listed without maintenance functions, it is solely for the purpose of having the group numbers in the MAC and RPSTL coincide.

d. Column 4, Maintenance Category. Column 4 specifies, by the listing of a "worktime" figure in the appropriate subcolumn(s), the lowest level of maintenance authorized to perform the function listed in column 3. This figure represents the active time required to perform that maintenance function at the indicated category of maintenance. If the number or complexity of the tasks within the listed maintenance function vary at different maintenance categories, appropriate "worktime" figures will be shown for each category. The number of task-hours specified by the "worktime" figure represents the average time required to restore an item (assembly, subassembly, component, module, end item or system) to a serviceable condition under typical field operating conditions. This time includes preparation time, troubleshooting time, and quality assurance/quality control time in addition to the time required to perform the specific tasks identified for the maintenance functions authorized in the maintenance allocation chart. Subcolumns of column 4 are as follows:

- C - Operator/Crew
- O - Organizational
- F - Direct Support
- H - General Support
- D - Depot

e. Column 5, Tools and Equipment. Column 5 specifies by code, those common tool sets (not individual tools) and special tools, test, and support equipment required to perform the designated function.

f. Column 6, Remarks. Column 6 contains an alphabetic code which leads to the remark in Section IV. Remarks, which is pertinent to the item opposite the particular code.

D-4. Tool and Test Equipment Requirements (Sect. III)

a. Tool or Test Equipment Reference Code. The numbers in this column coincide with the numbers used in the tools and equipment column of the MAC. The numbers indicate the applicable tool or test equipment for the maintenance functions.

b. Maintenance Category. The codes in this column indicate the maintenance category allocated the tool or test equipment.

c. Nomenclature. This column lists the noun name and nomenclature of the tools and test equipment required to perform the maintenance functions.

d. National/NATO Stock Number. This column lists the National INATO stock number of the specific tool or test equipment.

e. Tool Number. This column lists the manufacturer's part number of the tool followed by the Federal Supply Code for manufacturers (5-digit) in parentheses.

D-5. Remarks (Sect. IV)

a. Reference Code. This code refers to the appropriate item in section II, column 6.

6. Remarks. This column provides the required explanatory information necessary to clarify items appearing in section II.

**SECTION II. MAINTENANCE ALLOCATION CHART
FOR
ARRESTER, ELECTRICAL SURGE F-1433/G & F-1495/G**

(1) GROUP NUMBER	(2) COMPONENT ASSEMBLY	(3) MAINTENANCE FUNCTION	(4) MAINTENANCE CATEGORY					(5) TOOLS AND EQUIPMENT	(6) REMARKS	
			C	O	F	H	D			
00	ELECTRICAL SURGE ARRESTERS F-1493/G (SC-D-956112) and F-1495/G (SC-D-956111)	Inspect		0.1						
		Test		0.5						
		Test			1.0				2 2,5	A
		Test					1.0		2, 6 thru 13	B
		Service			0.1				1	
01	CIRCUIT BOARD ASSEMBLY A1, A2, A3 (SC-D-956116)	Replace			0.5				3	
		Repair					4.0		2, 5 thru 13	
		Overhaul					8.0		1 thru 13	
		Inspect		O i			0.1			
		Test					0.3		5 thru 13	
		Repair				0.9		2, 5 thru 13		

**SECTION III. TOOL AND TEST EQUIPMENT REQUIREMENTS
FOR
SURGE ARRESTERS, ELECTRICAL F-1483/G & F-1495/G**

TOOL OR TEST EQUIPMENT REF CODE	MAINTENANCE CATEGORY	NOMENCLATURE	NATIONAL/NATO STOCK NUMBER	TOOL NUMBER
1	0, F, H, D	TOOL KIT, ELECTRONIC EQUIPMENT TK-101/G	5180-00-064-5178	
2	0, F, H, D	MULTIMETER TS-352B/U	6625-00-553-0142	
3	F, H, D	TOOK KIT, ELECTRONIC EQUIPMENT TK-100/G	S80-00-605-0079	
4	F, H, D	TOOK KIT, ELECTRONIC EQUIPMENT TK-105/G	5180-00-610-8177	
5	F, H, D	SPECIAL TEST SET TS-3760/G	6625-01-100-6198	
6	D	AUDIO OSCILLATOR HP-200CD	6625-00-971-5966	
7	D	VTVI HP-400CD	6625-00-889-9939	
8	D	DISTORTION ANALYZER AN/URM-184	6625-00-802-8718	
9	D	OSCILLOSCOPE TEKTRONIX 485	6625-00-548-8181	
10	D	POWER SUPPLY 0-250 V.D.C. @ 10 mA		
11	D	POWER SUPPLY 0-12 kVDC		
12	D	POWER RESISTORS 600 Ohms		
13	D	VOLTAGE PROBES P-6015	6625-00-922-9296	

SECTION IV. REMARKS
ARRESTER, ELECTRICAL SURGE F-1483/G & F-1495/G

Reference Code	Remarks
A	Continuity/Diode Resistance Test
B	Verification Test

* U.S. GOVERNMENT PRINTING OFFICE: 1981-703-020/1282

By Order of the Secretary of the Army:

EDWARD C. MEYER
General, United States Army
Chief of Staff

Official:

ROBERT M. JOYCE
Brigadier General United States Army
The Adjutant General

DISTRIBUTION:

To be distributed in accordance with Special List.

RECOMMENDED CHANGES TO EQUIPMENT TECHNICAL PUBLICATIONS



THEN... JOT DOWN THE DOPE ABOUT IT ON THIS FORM, CAREFULLY TEAR IT OUT, FOLD IT AND DROP IT IN THE MAIL!

SOMETHING WRONG WITH THIS PUBLICATION?

FROM: (PRINT YOUR UNIT'S COMPLETE ADDRESS)

DATE SENT

PUBLICATION NUMBER PUBLICATION DATE PUBLICATION TITLE

BE EXACT... PIN-POINT WHERE IT IS				IN THIS SPACE TELL WHAT IS WRONG AND WHAT SHOULD BE DONE ABOUT IT:
PAGE NO.	PARA-GRAPH	FIGURE NO.	TABLE NO.	

PRINTED NAME, GRADE OR TITLE, AND TELEPHONE NUMBER

SIGN HERE:

TEAR ALONG PERFORATED LINE

This fine document...

Was brought to you by me:



[Liberated Manuals -- free army and government manuals](#)

Why do I do it? I am tired of sleazy CD-ROM sellers, who take publicly available information, slap “watermarks” and other junk on it, and sell it. Those masters of search engine manipulation make sure that their sites that sell free information, come up first in search engines. They did not create it... They did not even scan it... Why should they get your money? Why are not letting you give those free manuals to your friends?

I am setting this document FREE. This document was made by the US Government and is NOT protected by Copyright. Feel free to share, republish, sell and so on.

I am not asking you for donations, fees or handouts. If you can, please provide a link to liberatedmanuals.com, so that free manuals come up first in search engines:

<A HREF=<http://www.liberatedmanuals.com/>>Free Military and Government Manuals

- Sincerely
Igor Chudov
<http://igor.chudov.com/>
- [Chicago Machinery Movers](#)