

TECHNICAL MANUAL  
OPERATOR'S AND UNIT  
MAINTENANCE MANUAL"  
INCLUDING REPAIR PARTS  
AND SPECIAL TOOLS LIST  
FOR  
GROUNDING KIT, MK-2551A/U  
(NSN 5820-01-263-1760)RPSTL  
(EIC: N/A)

PMCS

OPERATION  
UNDER  
USUAL  
CONDITIONS

UNIT  
MAINTENANCE

RPSTL

DISTRIBUTION STATEMENT A: Approved for public release; distribution is unlimited.

---

HEADQUARTERS  
DEPARTMENT OF THE ARMY  
1 MAY 1994



**5**

**SAFETY STEPS TO FOLLOW IF SOMEONE IS THE VICTIM OF ELECTRICAL SHOCK**

**1**

**DO NOT TRY TO PULL OR GRAB THE INDIVIDUAL**

**2**

**IF POSSIBLE, TURN OFF THE ELECTRICAL POWER**

**3**

**IF YOU CANNOT TURN OFF THE ELECTRICAL POWER, PULL, PUSH OR LIFT THE PERSON TO SAFETY USING A DRY WOODEN POLE OR A DRY ROPE OR SOME OTHER INSULATING MATERIAL**

**4**

**SEND FOR HELP AS SOON AS POSSIBLE**

**5**

**AFTER THE INJURED PERSON IS FREE OF CONTACT WITH THE SOURCE OF ELECTRICAL SHOCK, MOVE THE PERSON A SHORT DISTANCE AWAY AND IMMEDIATELY START ARTIFICIAL RESUSCITATION**

## WARNING

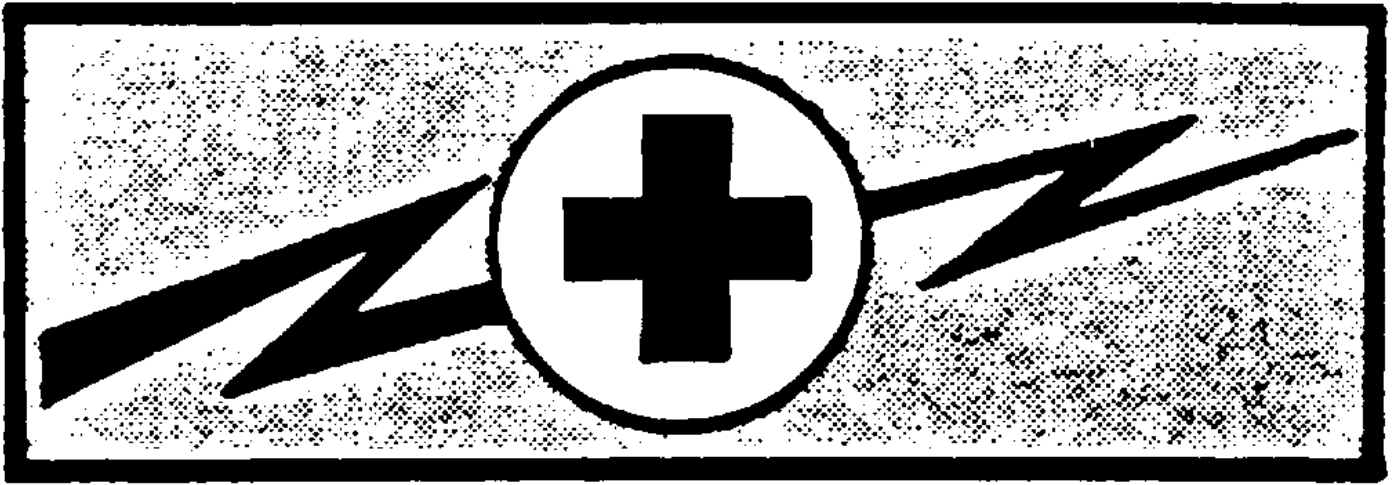

### HIGH VOLTAGE

is used in the operation of this equipment

### DEATH ON CONTACT

may result if personnel fail to observe safety precautions

Never work on electronic equipment unless there is another person nearby who is familiar with the operation and hazards of the equipment and who is competent in administering first aid. When the technicians are aided by operators, they must be warned about dangerous areas.

Whenever possible, the power supply to the equipment must be shut off before beginning work on the equipment. Take particular care to ground every capacitor likely to hold dangerous potential. When working inside the equipment, after the power has been turned off, always ground every part before touching it.

Be careful not to contact high voltage connections or 115 volt ac input connections when installing or operating this equipment.

Whenever the nature of the operation permits, keep one hand away from the equipment to reduce the hazard of current flowing through the body.

Warning: Do not be misled by the term "low voltage." Potentials as low as 50 volts may cause death under adverse conditions.

For Artificial Respiration, refer to FM 21 - 11

**b**

## WARNINGS

Do not attach ground to any pipe or container used for gasoline or other flammable gasses or liquids.

During thunderstorms, lightning flashover or arcing can occur between two or more unconnected or poorly connected adjacent metal structures. Flashover can cause lethal voltage on the ground in the vicinity of these objects

### LIGHTNING CAUTION FOR STAND-ALONE EQUIPMENT

When thunderstorms threaten, disconnect power from stand-alone equipment that is not sheltered by a separate lightning protection system Then separate all such equipment by at least 6 ft or bond them together with heavy copper cable.

Do not use the MK-2551A/U for multiple vehicles or multiple equipment grounding. The MK-2551A/U is intended for single unit applications only Do not cross power and signal cables when installing the MK-2551A/U.

<b>CAUTION</b>
----------------

Use gloves and safety goggles when handling and installing or removing the MK-2551A/U

### NOTE

**DO NOT TIE** the ground strap (or heavy wire substitute) to the rod or loop it around the rod. A knot or loop will greatly reduce the effectiveness of the ground The strap must be connected by the terminal screw, a clamp, or bound with wire to the rod.

**c**

**OPERATOR'S AND UNIT MAINTENANCE MANUAL  
INCLUDING REPAIR PARTS AND SPECIAL TOOLS LIST FOR  
GROUNDING KIT, MK-2551A/U  
(NSN 5820-01-263-1760) (EIC: N/A)**

**REPORTING ERRORS AND  
RECOMMENDING IMPROVEMENTS**

You can help improve this manual. If you find any mistakes or if you know of a way to improve the procedures, please let us know. Mail your letter or DA Form 2028 (Recommended Changes to Publications and Blank Forms), direct to: Commander, US Army Communications-Electronics Command and Fort Monmouth, ATTN. AMSELLC-LM-LT, Fort Monmouth, New Jersey 07703-5007.

A reply will be furnished to you.

<b>TABLE OF CONTENTS</b>		<u>Page</u>
CHAPTER 1	INTRODUCTION .....	1-1
Section I	General Information .....	1-1
Section II	Equipment Description .....	1-3
Section III	Principles of Operation .....	1-4
CHAPTER 2	OPERATING INSTRUCTIONS .....	2-1
Section I	Description and Use of Operators	
	Controls and Indicators .....	2-1
Section II	Operator Preventive Maintenance	
	Checks and Services (PMCS) .....	2-1
Section III	Operation Under Usual Conditions .....	2-3
Section IV	Operation Under Unusual Conditions .....	2-5

CHAPTER 3	OPERATOR MAINTENANCE .....	3-1
CHAPTER 4	UNIT MAINTENANCE .....	4-1
Section I	Repair Parts; Tools; Special Tools; Test, Measurement, and Diagnostic Equipment (TMDE); and, Support Equipment .....	4-1
Section II	Troubleshooting .....	4-1
Section III	Unit Maintenance .....	4-2
APPENDIX A	REFERENCES .....	A-1
APPENDIX B	MAINTENANCE ALLOCATION CHART .....	B-1
APPENDIX C	REPAIR PARTS AND SPECIAL TOOLS LIST .....	C-1
APPENDIX D	COMPONENTS OF END ITEM UST .....	D-1
	INDEX .....	INDEX-1

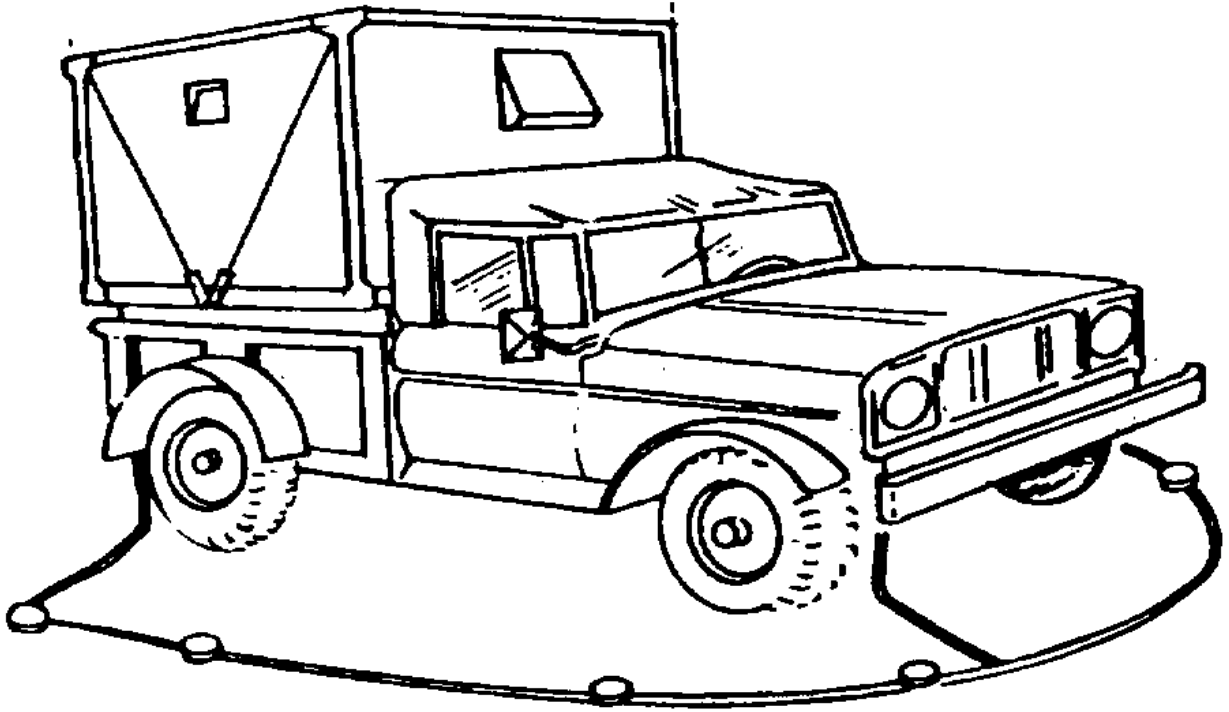

Grounding Kit, MK-2551A/U

(iii blank)/1-0

## CHAPTER 1

### INTRODUCTION

#### Section I. GENERAL INFORMATION

---

##### 1-1. SCOPE

- a. Type of manual. Operator's and Unit Maintenance Including Repair Parts and Special Tools Lists.
- b. Equipment name. Grounding Kit, MK-2551A/U
- c. Purpose of equipment. The MK-2551A/U is an alternative grounding system designed primarily for use in tactical operations for quick installation and tear-down. It can be easily installed and removed in situations where using conventional grounding rods would not be possible. It does not replace the ground rod, but is an option for use as situations or circumstances may warrant. The MK-2551A/U shall not be used as a permanent grounding system.

##### 1-2 CONSOLIDATED INDEX OF ARMY PUBLICATIONS AND BLANK FORMS

Refer to the latest issue of DA Pam 25-30 to determine whether there are new editions, changes, or additional publications pertaining to the equipment.

##### 1-3. MAINTENANCE FORMS, RECORDS, AND REPORTS

- a. Reports of Maintenance and Unsatisfactory Equipment. Department of the Army forms and procedures used for equipment maintenance will be those prescribed by DA Pam 738-750, as contained in Maintenance Management Update
- b. Report of Packaging and Handling Deficiencies. Fill out and forward SF 364 (Report of Discrepancy (ROD)) as prescribed in AR 735-11-2/DLAR 4140 55/SECNAVINST 4355.18/AFR 400-54/MCO 4430.3J.
- c. Transportation Discrepancy Report (TDR) (SF361). Fill out and forward Transportation Discrepancy Report (TDR) (SF 361) as prescribed in AR 55-38/NAVSUPINST 4610 33C/AFR 75-18/MCO P4610.19D/DLAR 4500.15.



#### **1-4 REPAIR PARTS AND SPECIAL TOOLS LIST (RPSTL)**

The RPSTL is included in this manual as Appendix C.

#### **1-5. REPORTING EQUIPMENT IMPROVEMENT RECOMMENDATIONS (EIR)**

If your MK-2551A/U needs improvement, let us know. Send us an EIR. You, the user, are the only one who can tell us what you don't like about your equipment. Let us know why you don't like the design or performance. Put it on an SF 368 Product Quality Deficiency Report). Mail it to: Commander, US Army Communications-Electronics Command and Fort Monmouth, ATTN: AMSEL-LC-ED-CFO, Fort Monmouth, New Jersey 07703-5007. We'll send you a reply.

#### **1-6. DESTRUCTION OF ARMY ELECTRONICS MATERIEL**

Destruction of Army electronics materiel to prevent enemy use shall be in accordance with TM 750-244-2.

#### **1-7. ADMINISTRATIVE STORAGE**

Administrative storage of equipment issued to and used by Army activities will have Preventive Maintenance Checks and Services (PMCS) performed before storing. When removing the equipment from administrative storage, the PMCS checks should be performed to assure operational readiness.

#### **1-8. SAFETY, CARE, AND HANDLING**

Voltage step potentials created by lightning strikes may make the soil near the MK-2551A/U more hazardous than the soil surrounding a single ground rod, since the MK-2551A/U does not penetrate deeply into the earth. This phenomena would be of very short duration, similar to the strike itself. Regardless of which grounding system is used, the soil in the immediate vicinity of the ground will be potentially dangerous during a lightning discharge. For this reason, personnel should make every effort to seek shelter within metal enclosures, vehicles, or other relatively safe locations when electrical storms are imminent. This same precaution applies even if a grounding system is not installed, since personnel may also become a possible target for a direct strike

## Section II. EQUIPMENT DESCRIPTION AND DATA

### 1-9. EQUIPMENT CHARACTERISTICS, CAPABILITIES, AND FEATURES

The MK-2551A/U provides a safe path to discharge lightning, enhancing safety of personnel and equipment. It also helps to control noise in signal circuits. The total resistance-to-ground ratio is equal to or better than that of a single ground rod, allowing the equipment to better survive a lightning strike than a single ground rod.

### 1-10. LOCATION AND DESCRIPTION OF MAJOR COMPONENTS

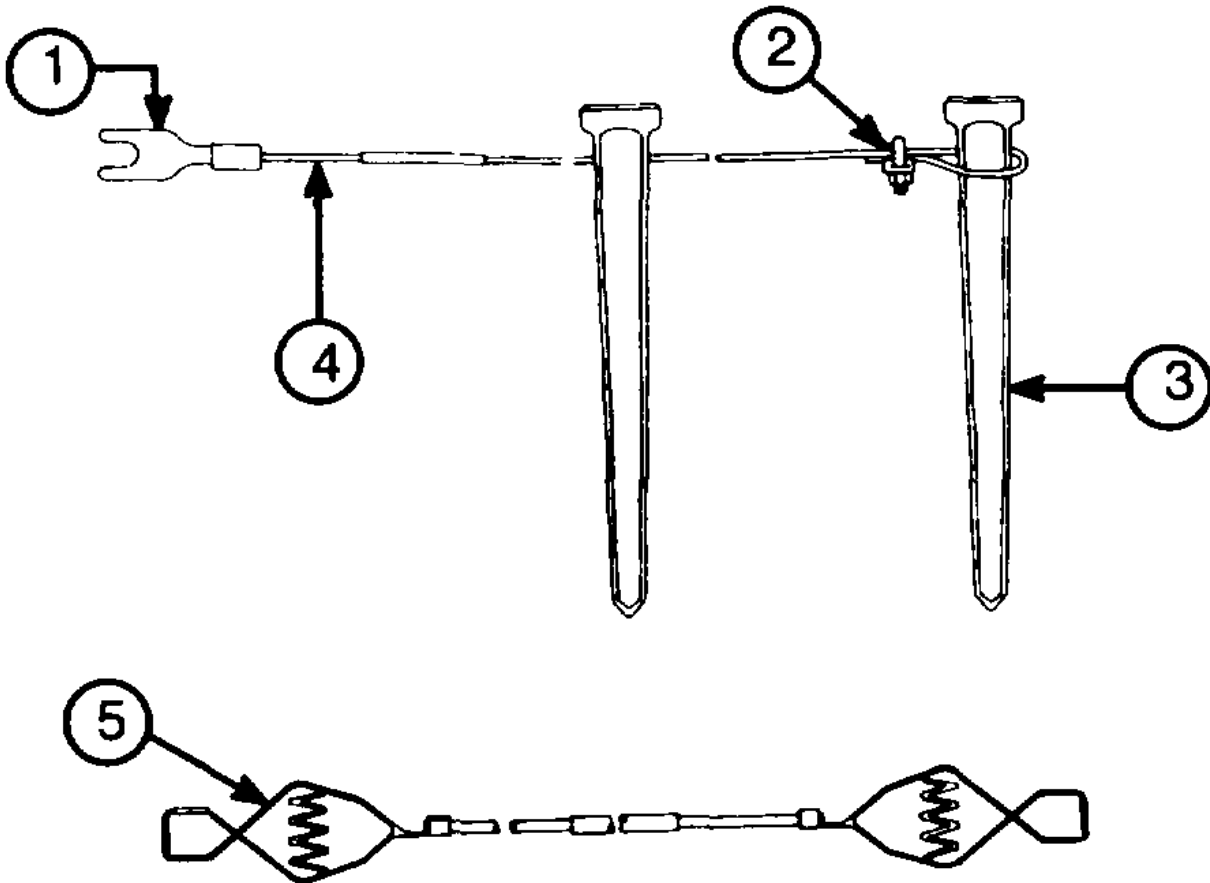

Table 1-1. Location of Major Components

Item	Nomenclature
1	Terminal lug
2	Clamp
3	Stake
4	Wire Assembly
5	Jumper Cable

### 1-11. EQUIPMENT DATA

The kit consists of 15 galvanized steel stakes captive on 20 meters (65 feet) of galvanized wire rope on a reel. All 15 pegs must be driven into the earth. Each peg has a star cross section and is tapered from the top to the bottom. The complete kit weighs 25 pounds, and includes a 3-pound hammer. The 65-foot wire and two 10 foot jumper cables will adequately protect a 5-ton truck.

### Section III. PRINCIPLES OF OPERATION

#### 1-12 THE EARTH GROUNDING SYSTEM

a Theory. An earth grounding system helps keep the electrical potential on metal surfaces at the same level as the surrounding earth. Earth grounding also provides a discharge path for externally generated electrical surges, including lightning. An earth ground is made by electrically connecting a generator, shelter or structure to a buried metal conductor which is in contact with moist subsoil or reaches into the underground water table. The type of ground conductor and method of installation you use depends on the climate and soil conditions of the site.

b Ground rods and plates. A ground rod is generally the most effective conductor. You may get a good ground by connecting to a buried metal object already at the site, such as a metal pipe or a steel building frame. In the desert or other places where

ground conductivity is poor, a ground plate or a group of ground rods electrically connected together will be more effective than a single ground rod. c Soils. Some types of soil provide better electrical grounds than others Use the type of ground conductor that works best for the soil In your location Here is a summary of soil types, grounding quality and suggested type of ground conductor.

TYPE OF SOIL	QUALITY OF GROUND	GROUND CONDUCTOR
Fine hard-packed sand with high moisture content	Very good	MK-2551A/U or Ground rod
Clay, loam or shale Ground rod	Good	MK-2551A/U or
Clay, loam or shale mixed with gravel or sand; or gravel, sand or stone ground plate.	Poor	MK-2551 A/U, large buried metal object, water pipe or
Loose gravel or sand surface deeper than 6 inches.	Poor	Large buried metal object, water pipe, ground plate or ground rod.
Permafrost	Poor	Large buried metal object, water pipe or MK-2551A/U if standard ground rods cannot be driven.

Under very poor or poor conditions, take special steps to establish and maintain electrical conductivity, as explained in Chapter 2, Section IV.

**CHAPTER 2**  
**OPERATING INSTRUCTIONS**

---

**Section I. DESCRIPTION AND USE OF OPERATOR'S CONTROLS AND INDICATORS**

**None.**

**Section II. OPERATOR PREVENTIVE MAINTENANCE CHECKS AND SERVICES (PMCS)**

**2-1 General.** Preventive Maintenance Checks and Services (PMCS) means systematic caring, inspecting, and servicing of your equipment to keep it in good condition and to prevent breakdowns.

a. Be sure to perform your BEFORE (B) PMCS each time you install the grounding kit. Always do your PMCS in the same order, so it gets to be a habit. Once you've had some practice, you'll quickly spot anything wrong. Pay attention to WARNINGS, CAUTIONS, and NOTES

b. Do your DURING (D) PMCS while your equipment is actually being T operated. Pay attention to WARNINGS, CAUTIONS, and NOTES

c. Do your AFTER (A) PMCS as you are removing your grounding kit Pay attention to WARNINGS, CAUTIONS, and NOTES

d. Use DA Form 2404 (Equipment Inspection and Maintenance Worksheet) to record any faults that you discover before or after operation, unless you can fix them. You DO NOT need to record faults that you fix.

**2-2. PMCS Procedures**

a. Your Preventive Maintenance Checks and Services, Table 2-1, lists inspections and care required to keep your grounding kit in good operating condition. It is set up so you can do your checks in a logical order.

b. The "INTERVAL" column of Table 2-1 tells you when to do a certain check or service

**NOTE**

The terms 'ready/available" and 'mission capable" refer to the same status: Equipment is on hand and ready to perform its combat mission (See DA Pam 738750).

- d. The "EQUIPMENT IS NOT READY/AVAILABLE IF:" column in Table 2-1 tells you when your grounding kit is non-mission capable and why it cannot be used
- e. If anything looks wrong and you can't fix it, write it on your DA Form 2404. IMMEDIATELY report it to your supervisor.
- f. When you check for 'operating condition, " you look at the component to see if it's serviceable.

*Table 2-1. Preventive Maintenance Checks and Services for Grounding Kit, MK-2551A/U*

Item No.	Interval	<u>Location</u> Item to Check/ Service	Procedure	Not Fully Mission Capable if:
1	Before	Cable Assy	Inspect cable for obvious breaks or kinks. Re-	Cable is broken, frayed or twisted.
2	Before	Clamp	place or straighten. Inspect for corrosion. Clean.	Clamp is corroded.
3	Before	Clamp	Inspect for proper connection. Tighten	Clamp is loose.

Table 2-1. Preventive Maintenance Checks and Services for Grounding Kit, MK-2551A/U - Continued

Item No.	Interval	<u>Location</u> Item to Check/ Service	Procedure	Not Fully Mission Capable if:
4	During	Grounding Kit	Inspect for damage if disturbed by personnel or vehicular movement. Reset stakes or cable.	Stakes or cable assy are not firmly in contact with soil and each other.
5	After	Clamp	Inspect for proper connection. Tighten.	Clamp is loose.
6	After	Clamp	Inspect for corrosion. Clean.	Clamp is corroded
7	After	Cable Assy	Inspect cable for obvious breaks or kinks. Replace or straighten.	Cable is broken, frayed or twisted.



### SECTION III. OPERATION UNDER USUAL CONDITIONS

#### 2-1. ASSEMBLY AND PREPARATION FOR USE

##### 2-1.1. Installation.

- Step 1. Ensure equipment power is not connected.
- Step 2. Remove Grounding Kit from tool bag.
- Step 3. Attach terminal lug to grounding stud on Power Entrance Panel of equipment being grounded.
- Step 4. Lay cable around the perimeter of equipment, distributing stakes evenly and creating an open-ended ("U" shaped) pattern with no overlapping of cables.

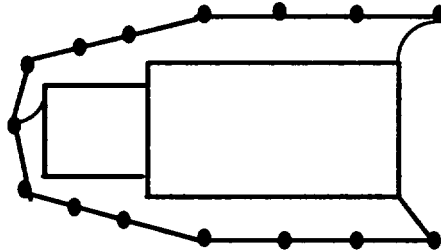

- Step 5. Begin with the stake closest to the grounding stud. Pull cable taut. Twist stake 30° to 45°. Drive stake until top is flush with ground. Continue until stakes are all driven into ground.
- Step 6. Attach jumper cables. Connect one from front bumper of vehicle to center of cable; connect second from rear bumper of vehicle to end of grounding cable.

##### 2-1.2. Removal

- Step 1. Disconnect equipment power and discharge supply capacitors.
- Step 2. Remove jumper cables.

- Step 3. Remove terminal lug from grounding stud on Power Entrance Panel.
- Step 4. Tap each peg from side to side using the hammer provided with the kit.
- Step 5. Once a peg is loosened, grasp the cable on both sides of it and pull up to remove.
- Step 6. Continue this procedure until all stakes are removed
- Step 7. Coil cables Place grounding kit and hammer in tool bag.

#### Section IV. OPERATION UNDER UNUSUAL CONDITIONS

##### 2-4. UNUSUAL ENVIRONMENT/WEATHER

2-4.1. Improving soil conductivity. In the event that you must ground your system in a soil that provides a poor soil conductivity (see table on page 1-5), you can take steps to improve the ground. Increase soil conductivity by adding salt and water, as shown in figure 2-1. Use water alone if salt is unavailable, Pour the water or mixture directly over the stakes of the MK-2551A/U. Clean the stakes upon removal if you use salt. Add more water daily.

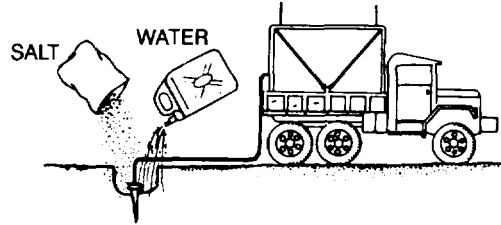

Figure 2-1

a. Desert.

(1) In the desert, the MK-2551A/U should work as well as a ground rod unless the sand is very loose. If the stakes of the MK-2551A/U are not secured well in the sand and are very loose, a ground rod or a ground plate may work better.

(2) To construct a ground plate, use a clean bare metal plate or sheet at least 3 feet square and at least 1/8 inch thick. Select a metal bolt nut and lock washer, then drill a hole in the center of the plate just large enough for the bolt. Fasten a ground strap to the plate as shown in figure 2-2. Make sure the connection is clean and tight. Bury the plate at least four feet underground. Apply salt and water as described in paragraph 2-3 1.

2-3. (3) Make a clean, tight connection to your equipment or shelter and check it every day.

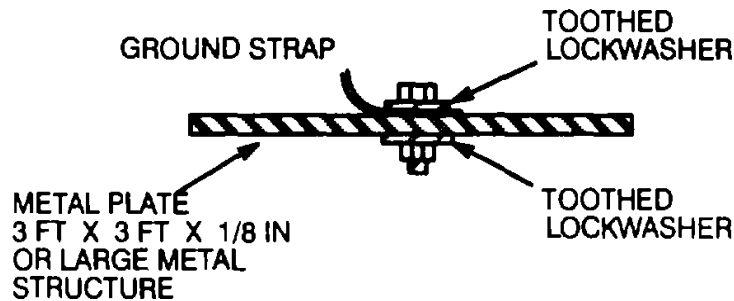
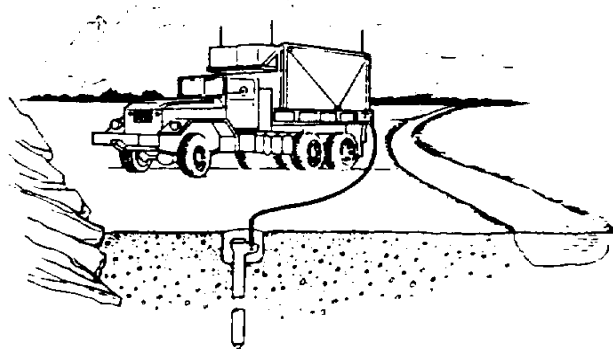

Figure 2-2.

b. Sandy soils, gravel, stones and soils mixed with gravel or sand. If the MK-2551 AIU stakes are very loose, a ground rod or plate will provide a better ground. In this soil type, it may be possible to sink the stakes deeper than flush with the surface, which will improve the ground. Keep the soil around the stakes moist, as described in paragraph 2-4.1

c. Mountains. It may be impossible to penetrate to moist soil or a water table in many mountainous areas. To properly ground your equipment, you must find a site where the grounding kit can be installed. Stream beds are usually the best locations. (See figure 2-3.)



*Figure 2-3.*

d. Tropics. Install the MK-2551A/U as described in paragraph 2-3. Because of the humidity, take care to keep the strap connections clean and dry. Pay special attention for corrosion. Cover the connection to the ground rod with waterproof tape and check it every day.

e. Arctic.

(1) Usually in permafrost type soil, a ground rod will provide a better ground, but it may be impossible to drive the ground rod to its full length. In this case, use the MK-2551A/U in accordance with paragraph 2-3. Use the soil enhancement procedures as described in paragraph 2-4.1. If frozen soil makes it difficult to drive the stakes of the MK-2551A/U into the ground, try to connect your equipment ground to a buried water pipe or other permanent buried metal structure.

(2) Snow is essentially an insulator and will not provide a good ground connection. Clear as much snow as possible before installing the MK-2551 A/U or other grounding electrode.

## **2-5. EMERGENCY PROCEDURES**

The danger of being struck directly by lightning exists if you remain in the open. Seek shelter. Stay as far as possible from the grounding kit during electrical storm conditions.

**2-7/(2-8 Blank)**

**CHAPTER 3**  
**OPERATOR'S MAINTENANCE**

---

There is no operator's maintenance authorized for the MK-2551 A/U.

**CHAPTER 4**  
**UNIT MAINTENANCE**

---

**Section I. REPAIR PARTS; TOOLS; SPECIAL TOOLS; TEST, MEASUREMENT, AND DIAGNOSTIC EQUIPMENT (TMDE); AND, SUPPORT EQUIPMENT**

**4-1. COMMON TOOLS AND EQUIPMENT.**

For authorized common tools and equipment, refer to the Modified Table of Organization and Equipment (MTOE), CTA 50-970, or CTA 8-100, as applicable to your unit.

**4-2. SPECIAL TOOLS, TMDE, AND SUPPORT EQUIPMENT.**

This information is contained in Appendix C

**4-3. REPAIR PARTS**

This information is contained in Appendix C.

**SECTION II. UNIT TROUBLESHOOTING PROCEDURES**

Check for proper connections; frayed cables; loose stakes; proper installation of jumper cables.

**3-1/4-1**

### **SECTION III. UNIT MAINTENANCE**

#### **4-4. REMOVE AND REPLACE TERMINAL LUG**

##### **Materials**

Terminal Lug,  
SC-C-681607

##### **Tools**

Wire cutters  
Tool, Crimping

##### **Remove.**

Step 1. Disconnect terminal lug from ground stud and remove jumper cables.

Step 2. Using wire cutters, cut old terminal lug from cable.

##### **Replace**

Step 1. Place new terminal lug on cable.

Step 2. Using crimping tool, connect terminal lug to cable.

Step 3. Reconnect terminal lug to ground stud and replace jumper cables.

#### **4-5. REMOVE AND REPLACE GROUND WIRE**

##### **Materials**

Wire Assembly, 65 feet  
SC-C-681613

##### **Tools**

Wrench, 7/16 inch  
Tool, Crimping

##### **Remove.**

Step 1. Disconnect terminal lug from ground stud and remove jumper cables

Step 2. Remove and retain clamp.

Step 3. Pull old cable out.

##### **Replace**

Step 1. Using crimping tool, connect terminal lug to cable.

Step 2. Thread new cable through stakes.

Step 3. Replace clamp.

Step 4. Reconnect terminal lug to ground stud and replace jumper cables.

#### 4-6. REMOVE AND REPLACE STAKES

##### Materials

Stake,  
SC-D-681612

##### Tools

Wrench, 7/16 inch

##### Remove.

Step 1. Disconnect terminal lug from ground stud and remove jumper cables.

Step 2. Remove clamp.

Step 3. Pull cable out until damaged stake is free.

Step 4. Remove damaged stake from ground.

##### Replace.

Step 1. Thread cable through new stake and through remaining stakes until all stakes are reattached.

Step 2. Replace clamp.

Step 3. Drive stakes in accordance with para 2-3.

Step 4 Reconnect terminal lug to ground stud and replace jumper cables.

#### 4-7. REPAIR JUMPER CABLES

##### Materials

Wire, Ground, 10 feet  
SC-C-681615-1  
PC Clip, 75 Amp

##### Tools

Wire cutters  
Tool, Crimping

Step 1. Disconnect terminal lug from ground stud and remove jumper cable(s).

Step 2. Using wire cutters, cut PC clip(s) from cable.

Step 3. Using crimping tool, crimp PC clip(s) to cable.

Step 4. Reconnect terminal lug to ground stud and replace jumper cable(s).

## APPENDIX A

### REFERENCES

---

#### A-1. SCOPE

This appendix lists all the forms and publications referred to in this manual.

#### A-2. REFERENCE LIST

AR 55-38/  
NAVSUPINST 4610.33C  
AFR 75-18/  
MCO P4610.19D  
DLAR 4500.15

Report of Transportation  
Discrepancies in Ship-  
ment

AR 735-11-2/  
DLAR 4140.55/  
SECNAVINST 4355.18/  
AFR 400-54/  
MCO 4430 3J

Reporting of Item and  
Packaging Discrepan-  
cies

DA 2028

Recommended Changes  
to Publications and  
Blank Forms

DA PAM 25-30

Consolidated Index of  
Army Publications and  
Blank Forms

DA PAM 738-750

The Army Maintenance  
Management System  
(TAMMS)

SF 364

Report of Discrepancy  
(ROD)

SF 368

Product Quality Deficien-  
cy Report

#### A-3. TECHNICAL MANUALS

TM 750-244-2

Destruction of Army  
Electronics Materiel



## APPENDIX B

### MAINTENANCE ALLOCATION

#### Section I. INTRODUCTION

##### B-1. GENERAL

This appendix provides a summary of the maintenance operations for Grounding Kit, MK-2551A/U. It authorizes levels of maintenance for specific maintenance functions of repairable items and components and the tools and equipment required to perform each function. This appendix may be used as an aid in planning maintenance operations.

##### B-2. MAINTENANCE FUNCTION

Maintenance functions will be limited to and defined as follows:

- a. Inspect. To determine the serviceability of an item by comparing its physical, mechanical, and/or electrical characteristics with established standards through examination.
- b. Test. To verify serviceability and to detect incipient failure by measuring the mechanical or electrical characteristics of an item and comparing those characteristics with prescribed standards.
- c. Service. Operations required periodically to keep an item in proper operating condition, i e., to clean (decontaminate), to preserve, to drain, to paint, or to replenish fuel, lubricants, hydraulic fluids, or compressed air supplies.
- d. Adjust. To maintain, within prescribed limits, by bringing into proper or exact position, or by setting the operating characteristics to the specified parameters.
- e. Align. To adjust specified variable elements of an item to bring about optimum or desired performance.

**B-1**

f. Calibrate. To determine and cause corrections to be made or to be adjusted on instruments or test measuring and diagnostic equipments used in precision measurement.

Consists of comparisons of two instruments, one of which is a certified standard of known accuracy, to detect and adjust any discrepancy in the accuracy of the instrument being compared.

g. Install The act of emplacing, seating, or fixing into position an item, part, module (component or assembly) in a manner to allow the proper functioning of the equipment or system.

h. Replace. The act of substituting a serviceable like type part, subassembly, or module (component or assembly) for an unserviceable counterpart.

i. Repair. The application of maintenance services (inspect, test, service, adjust, align, calibrate, replace) or other maintenance actions (welding, grinding, riveting, straightening, facing, remachining, or resurfacing) to restore serviceability to an item by correcting specific damage, fault, malfunction, or failure in a part, subassembly, module (component or assembly), end item, or system.

j. Overhaul. That maintenance effort (service/action) necessary to restore an item to a completely serviceable/operation- al condition as prescribed by maintenance standards (i.e., DMWR) in appropriate technical publications. Overhaul is normally the highest degree of maintenance performed by the Army. Overhaul does not normally return an item to like new condition

k. Rebuild. Consists of those services/actions necessary for the restoration of unserviceable equipment to a like new condition in accordance with original manufacturing standards Rebuild is the highest degree of materiel maintenance applied to Army equipment. The rebuild operation includes the act of returning to zero those age measurements (hours, miles, etc ) considered in classifying Army equipments/components

### **B-3. COLUMN ENTRIES**

a. Column 1, Group Number. Column 1 lists group numbers, the purpose of which is to identify components, assemblies, subassemblies, and modules with the next higher assembly

b. Column 2, Component/Assembly. Column 2 contains the noun names of components, assemblies, subassemblies, and modules for which maintenance is authorized.

c. Column 3, Maintenance functions. Column 3 lists the functions to be performed on the item listed in column 2. When Items are listed without maintenance functions, it is solely for purpose of having the group numbers in the MAC and RPSTL coincide

d. Column 4, Maintenance Level. Column 4 specifies, by the listing of a "work time" figure in the appropriate subcolumn(s), the lowest level of maintenance authorized to perform the function listed in column 3. This figure represents the active time required to perform that maintenance function at the indicated level of maintenance. If the number or complexity of the tasks within the listed maintenance function vary at different maintenance levels, appropriate "work time" figures will be shown for each level. The number of task-hours specified by the "work time" figure represents the average time required to re-store an item (assembly, subassembly, component, module, end item or system) to a serviceable condition under typical field operating conditions. This time includes preparation time, troubleshooting time, and quality assurance/quality control time in addition to the time required to perform the specific tasks identified for the maintenance functions authorized in the maintenance allocation chart. Subcolumns of column 4 are as follows

- C Operator/Crew
- O Organizational Maintenance/Aviation Unit Maintenance
- F Direct Support Maintenance/Aviation Intermediate Maintenance
- H General Support Maintenance

e. Column 5, Tools and Equipment. Column 5 specifies by code, those common tool sets (not individual tools) and special tools, test, and support equipment required to perform the designated function.

f. Column 6, Remarks. Column 6 contains an alphabetic code which leads to the remark in section IV, Remarks, which is pertinent to the item opposite the particular code.

**B-4. TOOL AND TEST EQUIPMENT REQUIREMENTS (Section III)**

a. Tool or Test Equipment Reference Code. The numbers in this column coincide with the numbers used in the tools and equipment column of the MAC. The numbers indicate the applicable tool or test equipment for the maintenance functions.

b. Maintenance Level. The codes in this column indicate the maintenance level allocated the tool or test equipment.

c. Nomenclature. This column lists the noun name and nomenclature of the tools and test equipment required to perform the maintenance functions.

d. National/NATO Stock Number. This column lists the National/NATO stock number of the specific tool or test equipment.

e. Tool Number. This column lists the manufacturer's part number of the tool followed by the Federal Supply Code for manufacturers (5-digit) in parentheses.

**B-5. REMARKS**

a. Reference Code. This code refers to the appropriate item in section II, column 6.

b. Remarks. This column provides the required explanatory information necessary to clarify items appearing in section II.



**Section III. TOOL AND TEST EQUIPMENT REQUIREMENTS  
FOR  
GROUNDING KIT, MK-2551A/U**

(1) TOOL OR TEST EQUIPMENT REF CODE	(2) MAINTENANCE LEVEL	(3) NOMENCLATURE	(4) NATIONAL/NATO STOCK NUMBER	(5) TOOL NUMBER
1	C, O	HAMMER		
2	0	WRENCH, 7/16 IN.		
3	0	WIRE CUTTER		
4	0	TOOL, CRIMPING		
B-6				

**Section IV. REMARKS**

<b>REFERENCE CODE</b>	<b>REMARKS</b>
A	Preventive Maintenance Checks and Services (PMCS).
B	Visual and mechanical function of the equipment.
	<p style="text-align: center;"><b>B-7</b></p>

## APPENDIX C

### REPAIR PARTS AND SPECIAL TOOLS LIST

#### C-1. SCOPE

This manual lists and authorizes spares and repair parts; special tools, special test, measurement, and diagnostic equipment (TMDE), and other special support equipment required for the performance of intermediate direct support and general support maintenance of Grounding Kit, MK-2551A/U. It authorizes the requisitioning, issue, and disposition of spares, repair parts and special tools as indicated by the source, maintenance, and recoverability (SMR) codes.

#### C-2. GENERAL

This Repair Parts and Special Tools List is divided into the following sections:

a. Section II. Repair Parts List. A list of spares and repair parts authorized by this RPSTL for use in the performance of maintenance. This list also includes parts which must be removed for replacement of the authorized parts. Parts lists are composed of functional groups in ascending item number sequence, with the parts in each group listed in ascending item number sequence. Figure numbers are listed directly beneath the group header. Bulk materials are listed in item name sequence. Repair part kits are listed separately in their own functional group within Section II. Repair parts for reparable special tools are also listed in this section. Items listed are shown on the associated illustration.

b. Section III. Special Tools List. Not applicable. A list of special tools, special TMDE, and other special support equipment authorized by this RPSTL as indicated by Basis of Issue (BOI) information in (column (5)) for the performance of maintenance.

c. Section IV. Cross-Reference Indexes. A list, in National item identification number (NIIN) sequence, of all National stock numbered items appearing in the listing, followed by a list in



alphameric sequence of all part numbers appearing in the listings. National stock numbers and part numbers are cross-referenced to each illustration figure and item number appearance. The figure number and item number index lists figure and item numbers in numeric sequence and cross-references National stock number, Commercial and Government Entity Code, and part numbers.

**C-3. EXPLANATION OF COLUMNS (Section II and III**

- a. Item No. (Column (1)). Indicates the number used to identify items called out in the illustrations.
- b. SMR Code (Column (2)). The source, maintenance, and recoverability (SMR) code is a five-position code containing supply/requisitioning information, maintenance category authorization criteria and disposition instruction, as shown in the following breakout:

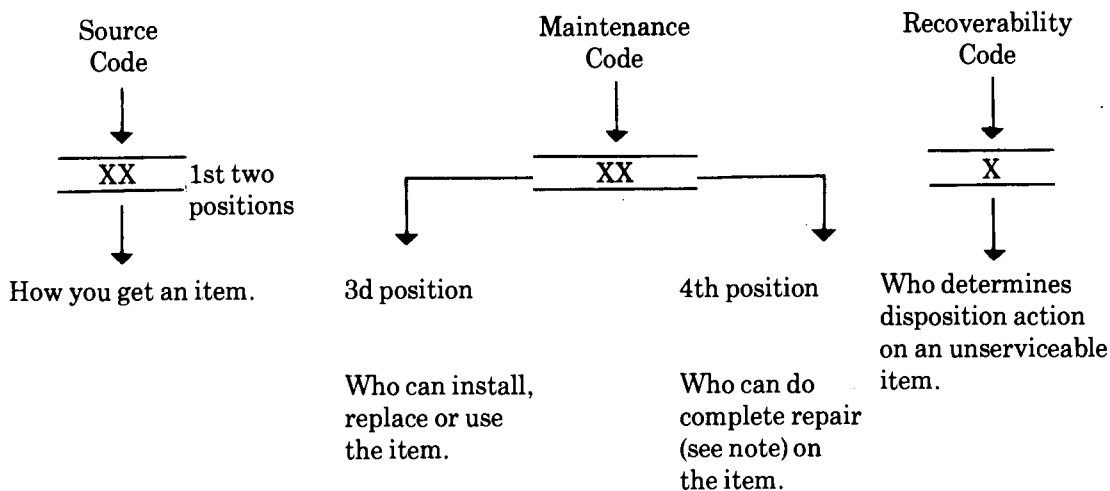

**NOTE**

Complete repair: Maintenance capacity, capability, and authority to perform all corrective maintenance tasks of the "repair" function in a use/user environment in order to restore serviceability to a failed item.

(1) Source code. The source code tells you how to get an item needed for maintenance, repair, or overhaul of an end item/equipment. Explanations of source codes follows

**Code**

**Explanation**

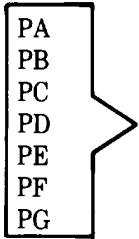

PA  
PB  
PC  
PD  
PE  
PF  
PG

Stocked items: use the applicable NSN to request/requisition items with these source codes. They are authorized to the level indicated by the code entered in the third position of the SMR code.

**NOTE**

Items coded PC are subject to deterioration.



KD  
KF  
KB

Items with these codes are not to be requested/requisitioned individually. They are part of a kit which is authorized to the maintenance category indicated in the third position of the SMR code. The complete kit must be requisitioned and applied.

MO—Made at org/  
AVUM category  
MF—Made at DS/  
AVUM category  
MH—Made at GS  
category  
ML—Made at  
Specialized  
Repair Activity  
(SRA)  
MD—Made at Depot

Items with these codes are not to be requested/requisitioned individually. They must be made from bulk material which is identified by the part number in the description and usable on (UOC) column and listed in the Bulk Material -group of the repair parts list. If the item is authorized to you by the third position code of the SMR code, but the source code indicates it is made at a higher category, of maintenance.

AO—Assembled by  
org/AVUM  
category  
AF—Assembled by  
DS/AVUM  
category  
AH—Assembled by  
GS category  
AL—Assembled by  
SRA  
AD—Assembled by  
Depot

Items with these codes are not to be requested/requisitioned individually. The parts that make up the assembled item must be requisitioned or fabricated and assembled at the category of maintenance indicated by source code. If the third position code of SMR code authorizes you to replace the item, but the source code indicates the item is assembled at a higher category, order the item from the higher category of maintenance.

<b>Code</b>	<b>Explanation</b>
XA	- Do not requisition an "XA" coded item Order its next higher assembly.
XB	- If an 'XB" item is not available from salvage, order it using the CAGEC and part number given.
XC	- Installation drawing, diagram, instruction sheet, field service drawing, that is identified by manufacturer's part number
XD	- Item is not stocked Order an "XD" coded item through normal supply channels using the CAGEC and part number given, if no NSN is available

**NOTE**

Cannibalization or controlled exchange, when authorized, may be used as a source of supply for items with the above source codes, except for those source coded "XA" or those aircraft support items restricted by requirements of AR 750-1.

(2) Maintenance code. Maintenance codes tell you the category of maintenance authorized to USE and REPAIR support items. The maintenance codes are entered in the third and fourth positions of the SMR code as follows.

(a) The maintenance code entered in the third position tells you the lowest maintenance category authorized to remove, replace, and use an item. The maintenance code entered in the third position will indicate authorization to one of the following categories of maintenance.

<b>Code</b>	<b>Application/Explanation</b>
C	- Crew or operator maintenance done within organizational or aviation maintenance.
O	- Organizational or aviation unit category can remove, replace, and use the item.
F	- Direct support or aviation intermediate category can remove, replace, and use the item.
H	- General support category can remove, replace, and use the item.
L	- Specialized repair activity can remove, replace, and use the item.
D	- Depot category can remove, replace, and use the item.

(b) The maintenance code entered in the fourth position tells whether or not the item is to be repaired and identifies the lowest maintenance category with the capability to do complete repair (i.e., perform all authorized repair functions). This position will contain one of the following maintenance codes.

**NOTE**

Some limited repair may be done on the item at a lower category of maintenance, if authorized by the Maintenance Allocation Chart (MAC) and SMR codes.

<b>Code</b>	<b>Explanation</b>
O	- Organizational or aviation unit is the lowest category that can do complete repair of the item.
F	- Direct support or aviation intermediate is the lowest category that can do complete repair of the item.
H	- General support is the lowest category that can do complete repair of the item.
L	- Specialized repair activity (designate the specialized repair activity) is the lowest category that can do complete repair of the item.
D	- Depot is the lowest category that can do complete repair of the item.
Z	- Nonreparable. No repair is authorized.
B	- No repair is authorized. (No parts or special tools are assigned for the maintenance of a "B" coded item.) However, the item may be reconditioned by adjusting, lubricating, etc., at the user category.

(3) Recoverability code. Recoverability codes are assigned to items to indicate the disposition action on unserviceable items. The recoverability code is entered in the fifth position of the SMR code as follows:

<b>Recoverability Code</b>	<b>Application/Explanation</b>
Z	- Nonreparable item. When unserviceable, condemn and dispose of the item at the category of maintenance shown in the third position of SMR code.
O	- Repairable item. When uneconomically repairable, condemn and dispose of the item at organizational or aviation unit category.

**Recoverability Code****Application/Explanation**

- F - Repairable item. When uneconomically repairable, condemn and dispose of the item at direct support or aviation intermediate category.
- H - Repairable item. When uneconomically repairable, condemn and dispose of the item at general support category.
- D - Repairable item. When beyond lower category repair capability, return to depot. Condemnation and disposal of item not authorized below depot category.
- L - Repairable item. Condemnation and disposal not authorized below specialized repair activity (SRA).
- A - Item requires special handling or condemnation procedures because of specific reasons (e.g., precious metal content, high dollar value, critical material, or hazardous material. Refer to appropriate manuals/directives for specific instructions

c. CAGEC (Column (3)). The Commercial and Government Entity Code (CAGEC) is a 5-digit numeric code which is used to identify the manufacturer, distributor, or Government agency, etc., that supplies the item

d. Part Number (Column (4)). Indicates the primary number used by the manufacturer (individual, company, firm, corporation, or Government activity), which controls the design and characteristics of the item by means of its engineering drawings, specifications, standards, and inspection requirements to identify an item or range of items.

**NOTE**

When you use an NSN to requisition an item, the item you receive may have a different part number from the part ordered.

e. Description and Usable on Code (UOC) (Column (5)). This column includes the following information.

(1) The Federal item name and, when required, a minimum description to identify the item

(2) The physical security classification of the item is indicated by the parenthetical entry (insert applicable physical security classification abbreviation, e.g., Phy Sec C1 (C) - Confidential, Phy Sec C1 (S) - Secret, Phy Sec C1 (T) - Top Secret)

(3) Items that are included in kits and sets are listed below the name of the kit or set.

(4) Spare/repair parts that make up an assembled item are listed immediately following the assembled item line entry.

(5) Part numbers for bulk materials are referenced in this column in the line entry for the item to be manufactured/fabricated.

(6) When the item is not used with all serial numbers of the same model, the effective serial numbers are shown on the last line of the description (before UOC).

(7) Usable on code, when applicable (para 5).

(8) In the Special Tools section, the basis of issue (BOI) appears as the last line in the entry for each special tool, special TMDE, and other special support equipment. When density of equipments supported exceeds density spread indicated in the basis of issue, the total authorization is increased proportionately.

(9) The statement "END OF FIGURE" appears just below the last item description in Column (5) for a given figure in both section II and section III.

f. Qty (Column (6)). Indicates the quantity of the item used in the breakout shown on the illustration figure, which is prepared for a functional group, subfunctional group, or an assembly. A "V" appearing in this column in lieu of a quantity Indicates that the quantity is variable and the quantity may vary from application to application

#### **C-4. EXPLANATION OF COLUMNS (Section IV)**

a. National Stock Number (NSN) Index.

(1) Stock number column. This column lists the NSN by National item identification number (NIIN) sequence. The NIIN consists of the last nine digits of the NSN. When using this

column to locate an item, ignore the first four digits of the NSN. When requisitioning items use the complete NSN (13 digits) sequence.

(2) Fig. column. This column lists the number of the figure where the item is identified/located. The illustrations are in numerical sequence in sections II and III.

(3) Item column. The item number identifies the item associated with the figure listed in the adjacent Fig. column. This item is also identified by the NSN listed on the same line.

b. Part Number Index. Part numbers in this index are listed by part number in ascending alphanumeric sequence.

(1) CAGEC column. This column lists the Commercial and Government Entity Code (CAGEC).

(2) Part number column. This column indicates the part number assigned to the item.

(3) Stock number column. This column lists the National stock number for the associated part number and manufacturer identified in the part number and CAGEC columns to the left.

(4) Fig. column. This column lists the number of the figure where the item is identified/located in sections II and III.

(5) Item column. The item number is that number assigned to the item as it appears in the figure referenced in the adjacent figure number column.

c. Figure and Item Number Index.

(1) Fig. column. This column lists the number of the figure where the item is identified/located in sections II and III.

(2) Item column. The item number is that number assigned to the item as it appears in the figure referenced in the adjacent figure number column.

(3) Stock number column. This column lists the National stock number for the item.

(4) CAGEC column. The Commercial and Government Entity Code (CAGEC) is a 5-digit numeric code used to identify the manufacturer, distributor, or Government agency, etc., that supplies the item.



(5) Part number column. Indicates the primary number used by the manufacturer (individual, firm, corporation, or Government activity), which controls the design and characteristics of the item by means of its engineering drawings, specifications, standards, and inspection requirements to identify an item or range of items.

**C-5. SPECIAL INFORMATION**

a. Usable on Code. The usable on code appears in the lower left corner of the description column heading. Usable on code- sare shown as 'UOC:" in the description column justified left) on the first line applicable item description nomenclature. Uncoded items are applicable to all models Identification of the usable on codes used in this RPSTL are:

<b>Code</b>	<b>Used on</b>
<b>N/A</b>	<b>N/A</b>

b. Fabrication Instructions. Bulk materials required to manufacture items are listed in the bulk material functional group of this RPSTL. Part numbers for bulk materials are also referenced in the description column of the line item entry for the item to be manufactured/fabricated Detailed fabrication instructions for items source coded to be manufactured or fabricated are not applicable.

c. Assembly Instructions. Detailed assembly instructions for items source coded to be assembled from component spare/ repair parts are found in xxxxxxxxxxxxxxxx. Items that make up the assembly are listed immediately following the assembly item entry or reference is made to an applicable figure.

d. Kits. Line item entries for repair part kits appear in a group in section II (refer to table of contents).

e. Index Numbers. Items which have the word BULK in the figure column will have an index number shown in the item number column. This index number is a cross-reference between the National Stock Number/Part Number Index and the bulk material list In section II.

f. Associated Publications, The publications listed below pertain to the MK-2551A/U and its components:

NONE

g. Illustrations Listing. Not applicable.

h. National Stock Numbers. National stock numbers (NSN's) that are missing from P source coded items have been applied for and will be added to this TM by future change/revision when they are entered in the Army Master Data File (AMDF). Until the NSN's are established and published, submit exception requisitions to: Commander, US Army Communications-Electronics Command and Fort Monmouth, ATTN: AMSELLC-MM, Fort Monmouth, NJ 07703-5007 for the part required to support your equipment.

#### **C-6. HOW TO LOCATE REPAIR PARTS**

a. When National stock number or part number is not known.

(1) First Using the table of contents, determine the assembly group or subassembly group to which the item belongs. This is necessary since figures are prepared for assembly groups and subassembly groups, and listings are divided into the same groups.

(2) Second. Find the figure covering the assembly group or subassembly group to which the item belongs.

(3) Third. Identify the item on the figure and note the item number.

(4) Fourth. Refer to the Repair Parts Lists for the figure to find the part number for the item number noted on the figure.

(5) Fifth. Refer to the Part Number Index to find the NSN, if assigned.

b. When National stock number or part number is known.

(1) First. Using the index of National stock numbers and part numbers, find the pertinent National stock number or part number. The NSN index is in National item identification number (NIIN) sequence (para 4a(1)). The part numbers in the part number index are listed in ascending alphameric sequence (para 4b). Both indexes cross-reference you to the illustration figure and item number of the item you are looking for.

(2) Second. After finding the figure and item number, verify that the item is the one you're looking for, then locate the item number in the repair parts list for the figure.

#### **C-7. ABBREVIATIONS**

Not applicable.

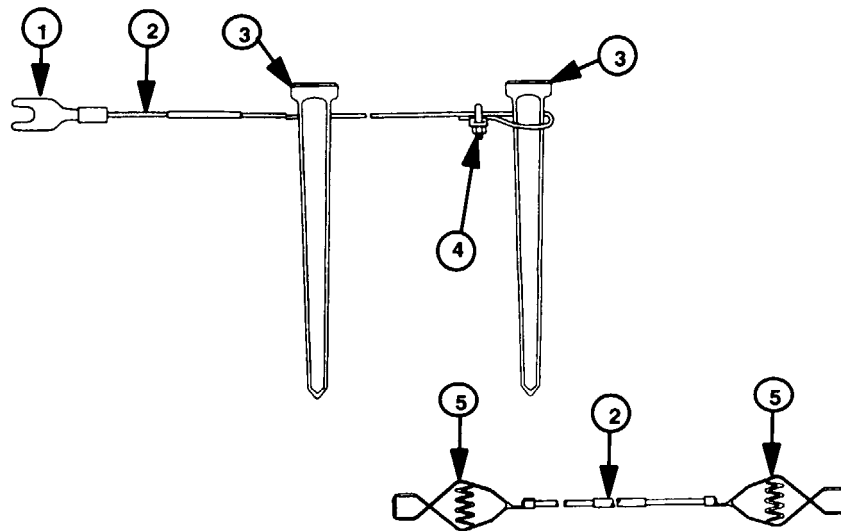

Figure 1. Group 00: MK-2551 A/U (sheet 1 of 2)  
C-13

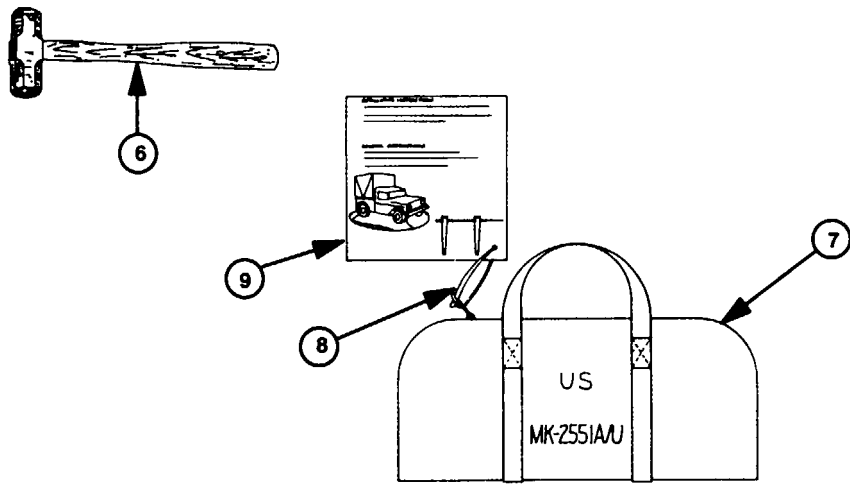

Figure 1. Group 00: MK-2551A?U (Sheet 20f 2)  
C-14

(1) ITEM NO	(2) SMR CODE	(3) CAGEC	(4) PART NUMBER	(5) DESCRIPTION AND USABLE ON CODE (UOC)	(6) QTY
				00 GROUNDING KIT, MK-2551A/U FIGURE 1	
1	PAOZZ	80063	SC-C-681607	Terminal, Lug	1
2	PAOZZ	19207	856468	Rope, Wire	V
3	PAOZZ	80063	SC-D-681612	Stake, Guy	15
4	PAOZZ	96906	MS16842-2	Clamp, Wire Rope, SAD	1
5	PAOZZ	80063	SM-B-540574	Clip, Electrical	2
6	PAOZZ	26916	33A271	Hammer, Hand	1
7	PAOZZ	34623	11655979	Bag, Tool, Satchel	1
8	PAOZZ	96906	MS3367-3	Strap, Tiedown Elect	1
9	PAOZZ	80063	SC-C-681614	Sheet, Technical	1

END OF FIGURE

**C-15**

**CROSS REFERENCE INDEXES**

**FIGURE AND ITEM NUMBER INDEX**

<b>FIG.</b>	<b>ITEM</b>	<b>STOCK NUMBER</b>	<b>CAGEC</b>	<b>PART NUMBER</b>
C-1	1	5940-01-383-0447	80063	SC-C-681607
C-1	2	4010-00-032-2938	19207	856468
C-1	3	4030-01-383-6690	80063	SC-D-681612
C-1	4	4030-00-233-9567	96906	MS16842-2
C-1	5	5999-00-832-4373	80063	SM-B-540574
C-1	6	5120-00-203-4656	26916	33A271
C-1	7	5140-00-473-6256	34623	11655979
C-1	8	5975-01-273-8133	96906	MS3367-3
C-1	9	7610-01-385-2947	80063	SC-C-681614

**CROSS-REFERENCE INDEXES**

**PART NUMBER INDEX**

<b>CAGEC</b>	<b>PART NUMBER</b>	<b>STOCK NUMBER</b>	<b>FIG.</b>	<b>ITEM</b>
96906	MS16842-2	4030-00-233-9567	C-1	4
96906	MS3367-3	5975-01-273-8133	C-1	8
80063	SC-C-681607	5940-01-383-0447	C-1	1
80063	SC-C-681614	7610-01-385-2947	C-1	9
80063	SC-D-681612	4030-01-383-6690	C-1	3
80063	SM-B-540574	5999-00-832-4373	C-1	5
34623	11655979	5140-00-473-6256	C-1	7
26916	33A271	5120-00-203-4656	C-1	6
19207	856468	4010-00-032-2938	C-1	2



**CROSS- REFERENCE-INDEXES**

**NATIONAL STOCK NUMBER INDEX**

<b>STOCK NUMBER</b>	<b>FIG.</b>	<b>ITEM</b>	<b>STOCK NUMBER</b>	<b>FIG.</b>	<b>ITEM</b>
4010-00-032-2938	C-1	2			
5120-00-203-4656	C-1	6			
4030-00-233-9567	C-1	4			
5140-00-473-6256	C-1	7			
5999-00-832-4373	C-1	5			
5975-01-273-8133	C-1	8			
5940-01-383-0447	C-1	1			
4030-01-383-6690	C-1	3			
7610-01-385-2947	C-1	9			

## APPENDIX D

### COMPONENTS OF END ITEM LIST

#### Section I. INTRODUCTION

##### D-1. SCOPE

This appendix lists integral components of and basic issue items for the TK-2551AJU to help you inventory items required for safe and efficient operation.

##### D-2. GENERAL

This Components of End Item List is divided into the following sections:

a. Section II. Integral Components of the End Item. These items, when assembled, comprise the TK-2551A/U and must accompany it whenever it is transferred or turned in. The illustrations will help you identify these items.

b. Section III. Basic Issue Item. Not applicable.

##### D-3. EXPLANATION OF COLUMNS

a. Illustration. This column is divided as follows:

(1) Figure number. Indicates the figure number of the illustration on which the item is shown.

(2) Item number. The number used to identify item called out in the illustration.

b. National Stock Number. Indicates the National stock number assigned to the item and which will be used for requisitioning.

c. Description. Indicates the federal item name and, if required, a minimum description to identify the item. The part number indicates the primary number used by the manufacturer, which controls the design and characteristics of the item by means of its engineering drawings, specifications, standards, and inspection requirements to identify an item or range of items. Following the part number, the Commercial and Government Entity Code (CAGEC) is shown in parentheses.

d. Location. The physical location of each item listed is given in this column. The lists are designed to inventory all items in one area of the major item before moving on to an adjacent area.

e. Usable on Code. Not applicable. "USABLE ON" codes are included to help you identify which component items are used on the different models. Identification of the codes used in these lists are:

Code	Used on
N/A	N/A

f. Quantity Required (Qty Reqd). This column lists the quantity of each item required for a complete major item.

g. Quantity. This column is left blank for use during an inventory. Under the Rcvd column, list the quantity you actually receive on your major item. The Date columns are for your use when you inventory the major item.

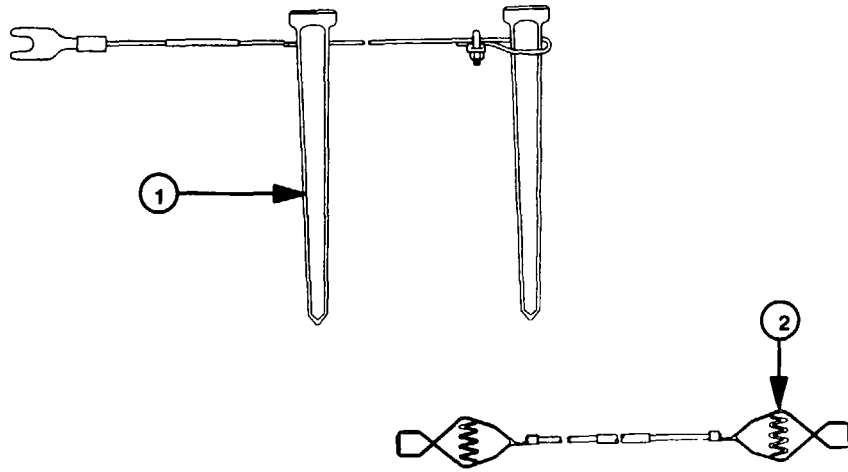

Figure D-1 Components of End Item (Sheet 1 of 2)  
D-3

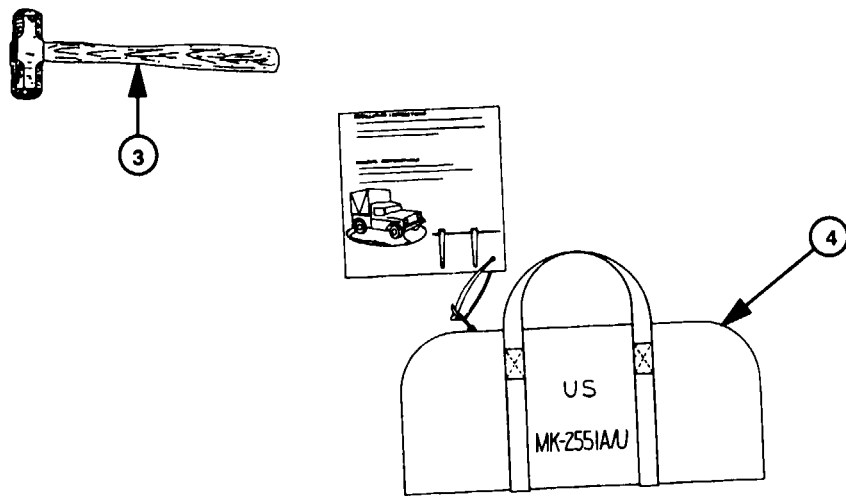

Figure D- 4. Components of End Item (Sheet 2 of 2)  
D-4

(1) ILLUS NUMBER	(2) NATIONAL STOCK NUMBER	(3) DESCRIPTION, CAGEC and Part Number	Usable On Code	(4) U/M	(5) QTY Reqd
1 2 3 4	Ground Wire Assembly Short, Ground Wire Assembly Hammer, Double Face Bag, Tool, Satchel				1 2 1 1

D-5/(D-6 blank)

## APPENDIX E

### INDEX

<b>Title</b>		<b>Page No.</b>
	<b>A</b>	
Administrative Storage .....		1-2
Assembly and Preparation for Use .....		2-4
	<b>C</b>	
Common Tools and Equipment . .....		4-1
Components of End Item List .....		D-1
	<b>D</b>	
Description and Use of Operator's Controls and Indicators .....		2-1
Destruction of Army Electronics Materiel .....		1-2
	<b>E</b>	
Earth Grounding System .....		1-4
Emergency Procedures .....		2-7
Equipment Characteristics, Capabilities and Features.....		1-3
Equipment Data .....		1-4
	<b>F</b>	
Ground Wire, Remove and Replace .....		4-2
	<b>I</b>	
Index of Army Pubs and Blank Forms .....		1-1
	<b>J</b>	
Jumper Cables, Remove, Replace and Repair .....		4-2
	<b>L</b>	
Location and Description of Major Components .....		1-3

**L - continued**

Lubrication Instructions ..... 4-1

**M**

Maintenance Allocation ..... B-1

Maintenance Allocation Chart ..... B-5

Maintenance Forms, Records, and Reports ..... 1-1

**O**

Operator Preventive Maintenance Checks and Services (PMCS) ..... 2-1

Operator's Maintenance ..... 3-1

Operation Under Usual Conditions ..... 2-4

Operation Under Unusual Conditions ..... 2-5

**R**

References ..... A-1

Remove and Replace Stakes ..... 4-2

Terminal Lug ..... 4-2

Ground Wire ..... 4-2

Repair Jumper Cables ..... 4-2

Repair Parts and Special Tools List ..... C-1

Reporting Equipment Improvement ..... 1-2

Recommendations (EIR) ..... 1-2

**S**

Safety, Care, and Handling ..... 1-2

Scope ..... 1-1

**Index-2**



**S - continued**

Special Tools, TMDE, and Support Equipment ..... 4-1

Stakes, Remove and Replace ..... 4-2

**T**

Terminal Lug, Remove and Replace ..... 4-2

**U**

Unusual Environment/Weather ..... 2-5

Unit Maintenance ..... 4-1,  
4-2

Unit Troubleshooting Procedures ..... 4-1

**Index-3**

By Order of the Secretary of the Army:

GORDON R SULLIVAN  
General, United States Army  
Chief of Staff

Official:

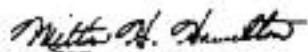

MILTON H HAMILTON  
Administrative Assistant to the  
Secretary of the Army

DISTRIBUTION:

To be distributed in accordance with DA Form 12-36-E, block 9679 requirements for TM 1]-5820-1118-126P.

U.S. GOVERNMENT PRINTING OFFICE: 1994- 510-106/00230

RECOMMENDED CHANGES TO EQUIPMENT TECHNICAL PUBLICATIONS



THEN... JOT DOWN THE DOPE ABOUT IT ON THIS FORM, CAREFULLY TEAR IT OUT, FOLD IT AND DROP IT IN THE MAIL!

**SOMETHING WRONG WITH THIS PUBLICATION?**

FROM: (PRINT YOUR UNIT'S COMPLETE ADDRESS)

DATE SENT

PUBLICATION NUMBER

PUBLICATION DATE

PUBLICATION TITLE

BE EXACT... PIN-POINT WHERE IT IS

PAGE NO.

PARA-GRAPH

FIGURE NO.

TABLE NO.

IN THIS SPACE TELL WHAT IS WRONG AND WHAT SHOULD BE DONE ABOUT IT:

TEAR ALONG PERFORATED LINE

PRINTED NAME, GRADE OR TITLE, AND TELEPHONE NUMBER

SIGN HERE:

DA FORM 2028-2  
1 JUL 79

PREVIOUS EDITIONS ARE OBSOLETE.

P.S.—IF YOUR OUTFIT WANTS TO KNOW ABOUT YOUR RECOMMENDATION MAKE A CARBON COPY OF THIS AND GIVE IT TO YOUR HEADQUARTERS.

# THE METRIC SYSTEM AND EQUIVALENTS

## WEIGHT MEASURE

1 Centimeter = 10 Millimeters = 0.01 Meters = 0.3937 Inches  
 1 Meter = 100 Centimeters = 1000 Millimeters = 39.37 Inches  
 1 Kilometer = 1000 Meters = 0.621 Miles

## WEIGHTS

Gram = 0.001 Kilograms = 1000 Milligrams = 0.035 Ounces  
 1 Kilogram = 1000 Grams = 2.2 lb.  
 1 Metric Ton = 1000 Kilograms = 1 Megagram = 1.1 Short Tons

## LIQUID MEASURE

1 Milliliter = 0.001 Liters = 0.0338 Fluid Ounces  
 1 Liter = 1000 Milliliters = 33.82 Fluid Ounces

## SQUARE MEASURE

1 Sq. Centimeter = 100 Sq. Millimeters = 0.155 Sq. Inches  
 1 Sq. Meter = 10,000 Sq. Centimeters = 10.76 Sq. Feet  
 1 Sq. Kilometer = 1,000,000 Sq. Meters = 0.386 Sq. Miles

## CUBIC MEASURE

1 Cu. Centimeter = 1000 Cu. Millimeters = 0.06 Cu. Inches  
 1 Cu. Meter = 1,000,000 Cu. Centimeters = 35.31 Cu. Feet

## TEMPERATURE

$5/9(^{\circ}\text{F} - 32) = ^{\circ}\text{C}$   
 212° Fahrenheit is equivalent to 100° Celsius  
 90° Fahrenheit is equivalent to 32.2° Celsius  
 32° Fahrenheit is equivalent to 0° Celsius  
 $9/5^{\circ}\text{C} + 32 = ^{\circ}\text{F}$

## APPROXIMATE CONVERSION FACTORS

TO CHANGE	TO	MULTIPLY BY
Inches	Centimeters	2.540
Feet	Meters	0.305
Yards	Meters	0.914
Miles	Kilometers	1.609
Square Inches	Square Centimeters	6.451
Square Feet	Square Meters	0.093
Square Yards	Square Meters	0.836
Square Miles	Square Kilometers	2.590
Acres	Square Hectometers	0.405
Cubic Feet	Cubic Meters	0.028
Cubic Yards	Cubic Meters	0.765
Fluid Ounces	Milliliters	29.573
its	Liters	0.473
arts	Liters	0.946
allons	Liters	3.785
Ounces	Grams	28.349
Pounds	Kilograms	0.454
Short Tons	Metric Tons	0.907
Pound-Feet	Newton-Meters	1.356
Pounds per Square Inch	Kilopascals	6.895
Miles per Gallon	Kilometers per Liter	0.425
Miles per Hour	Kilometers per Hour	1.609

TO CHANGE	TO	MULTIPLY BY
Centimeters	Inches	0.394
Meters	Feet	3.280
Meters	Yards	1.094
Kilometers	Miles	0.621
Square Centimeters	Square Inches	0.155
Square Meters	Square Feet	10.764
Square Meters	Square Yards	1.196
Square Kilometers	Square Miles	0.386
Square Hectometers	Acres	2.471
Cubic Meters	Cubic Feet	35.315
Cubic Meters	Cubic Yards	1.308
Milliliters	Fluid Ounces	0.034
Liters	Pints	2.113
Liters	Quarts	1.057
ers	Gallons	0.264
ms	Ounces	0.035
ograms	Pounds	2.205
Metric Tons	Short Tons	1.102
Newton-Meters	Pounds-Feet	0.738
Kilopascals	Pounds per Square Inch	0.145
ometers per Liter	Miles per Gallon	2.354
ometers per Hour	Miles per Hour	0.621

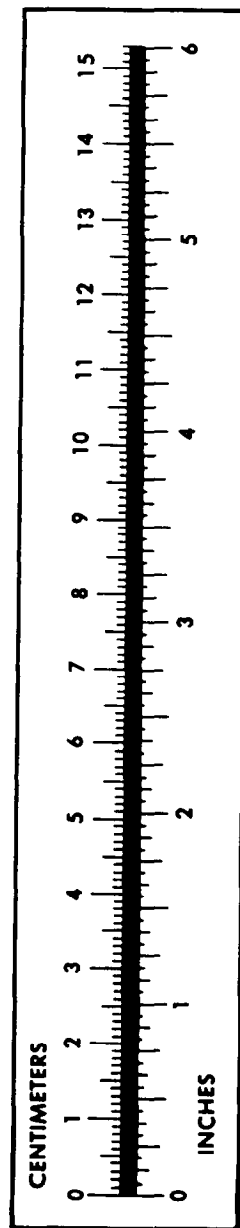

**PIN: 072562-000**

This fine document...

Was brought to you by me:



## [Liberated Manuals -- free army and government manuals](#)

Why do I do it? I am tired of sleazy CD-ROM sellers, who take publicly available information, slap “watermarks” and other junk on it, and sell it. Those masters of search engine manipulation make sure that their sites that sell free information, come up first in search engines. They did not create it... They did not even scan it... Why should they get your money? Why are not letting you give those free manuals to your friends?

I am setting this document FREE. This document was made by the US Government and is NOT protected by Copyright. Feel free to share, republish, sell and so on.

I am not asking you for donations, fees or handouts. If you can, please provide a link to [liberatedmanuals.com](http://liberatedmanuals.com), so that free manuals come up first in search engines:

<A HREF=<http://www.liberatedmanuals.com/>>Free Military and Government Manuals</A>

- Sincerely  
Igor Chudov  
<http://igor.chudov.com/>
- [Chicago Machinery Movers](#)