

TECHNICAL MANUAL

**ORGANIZATIONAL MAINTENANCE
REPAIR PARTS AND SPECIAL TOOLS LISTS
FOR**

**TERMINAL SET,
TELEPHONE AN / TCC-65
(NSN 5805-00-868-8215)**

HEADQUARTERS , DEPARTMENT OF THE ARMY

JUNE 1976

Organizational Maintenance Repair Parts and Special Tools Lists

for

TERMINAL SET , TELEPHONE AN/TCC-65

(NSN 5805-00-868-8215)

Current as of 1 January 1976

REPORTING OF ERRORS

You can improve this manual by recommending improvements using DA Form 2028-2 (Test) located in the back of the manual. Simply tear out the self-addressed form , fill it out as shown on the sample , fold it where shown , and drop it in the mail.

If there are no blank DA Forms 2028-2 (Test) in the back of your manual , use the standard DA Form 2028 (Recommended Changes to Publications and Blank Forms) and forward to the Commander , US Army Electronics Command , ATTN: DRSEL-MA-Q , Fort Monmouth , NJ 07703.

In either case a reply will be furnished direct to you.

Table of Contents

	Page	Illus Figure
Section I. Introduction	1	
II. Repair parts list	5	
Group 00 Telephone Terminal AN/TCC-65	5	1
01 Shelter. Facility S-333/TCC-65.....	7	2-9
02 Converter. Telephone Signal CV-1548/G (See TM 11-5805-367-25P/5 for parts)		
03 Intercommunication Station LS-147C/F1 (See TM 11-5830-221-24P for parts)		
04 Key Generator , Electronic TSEC/KG-27 (See TM 11-5810.232-12P for parts)		
0401 Installation kit. TSEC/KG-27	27	10
0402 Loop-back kit. TSEC/KG-27	29	11
05 Multiplexer TD-204/U (See TM 11-5805-367-25P/2 for parts) or Multiplexer TD-754/G (See TM 11-5805-383-12)		
06 Multiplexer TD-660/G or TD-660A/G (See TM 11-5805-382-12 for parts)		
07 Telephone Set TA-312/PT (See TM 11-5805-201-12 for parts)		
Section III. Special tools list (Not applicable).....		
IV. National stock number and part number index.....	30	

• This manual supersedes so much of TM 11-5805-371-15 , 9 May 1969 including all changes. As pertains to organizational repair parts and special tools list.

SECTION I

INTRODUCTION

1. Scope

This manual lists repair parts; special tools; and other support equipment required for performance of organizational maintenance of the Terminal Set , Telephone AN/TCC-65.

2. General

This Repair Parts and Special Tools List is divided into the following sections:

a. *Section II. Repair Parts List.* A list of repair parts authorized for use in performance of maintenance. The list also includes parts which must be removed for replacement of the authorized parts. Parts lists are composed of functional groups in ascending numerical sequence , with the parts in each group listed in figure and item number sequence.

b. *Section III. Special Tools List.* Not applicable.

c. *Section IV. National Stock Number and Part Number Index.* A list , in ascending National item identification number (NIIN , last 9 digits) sequence , of all National stock numbers appearing in the listings , followed by a list , in alphabetic sequence , of all part numbers appearing in the listings. National stock number and part numbers are cross-referenced to each illustration figure and item number appearance.

3. Explanation of Columns

The following provides an explanation of columns found in the tabular listings:

a. *Illustration.* This column is divided as follows:

(1) Figure number. Indicates the figure number of the illustration in which the item is shown.

(2) Item number. The number used to identify each item called out in the illustration.

b. *Source , Maintenance , and Recoverability Codes (SMR)*.

(1) *Source code.* Source codes are assigned to support items to indicate the manner of acquiring support items for maintenance , repair , or overhaul of end items. Source codes are entered in the first and second positions of the Uniform SMR Code format as follows:

<i>Code</i>	<i>Definition</i>
PA -	Item procured and stocked for anticipated or known usage.
PD -	Support item , excluding support equipment. procured for initial issue or outfitting and stocked only for subsequent or additional initial issues or outfittings. Not subject to automatic replenishment.
XD -	A support item that is not stocked. When required , item will be procured through normal supply channels.

NOTE

Cannibalization or salvage may be used as a source of supply for any items source coded above except those coded XA , XD , and aircraft support items as restricted by AR 700-42.

(2) *Maintenance code.* Maintenance codes are assigned to indicate the levels of maintenance authorized to USE and REPAIR support items. The maintenance codes are entered in the third and fourth positions of the Uniform SMR Code format as follows:

(a) The maintenance code entered in the third position will indicate the lowest maintenance level authorized to remove , replace , and use the support item. The maintenance code entered in the third position will indicate one of the following levels of maintenance:

<i>Code</i>	<i>Definition</i>
O -	Support item is removed , replaced , and used at the organizational level.

(b) The maintenance code entered in the fourth position indicates whether the item is to be repaired and identifies the lowest maintenance level with the capability to perform complete repair (i.e. , all authorized maintenance functions). This position will contain one of the following maintenance codes:

<i>Code</i>	<i>Definition</i>
D -	The lowest maintenance level capable of complete repair of the support item is the depot level.
F --	The lowest maintenance level capable of complete repair of the support item is the direct support level.
Z -	Nonreparable. No repair is authorized.
H -	The lowest maintenance level capable of complete repair of the support item is the general support level.

(3) *Recoverability code.* Recoverability codes are assigned to support items to indicate the disposition action on unserviceable items. The recoverability code is entered in the fifth position of the Uniform SMR Code format as follows:

<i>Recoverability codes</i>	<i>Definition</i>
Z	- Nonreparable item. When unserviceable , condemn and dispose at the level indicated in position 3.
F	- Reparable item. When uneconomically reparable , condemn and dispose at the direct support level.
H	- Reparable item. When uneconomically reparable , condemn and dispose at the general support level.
D	- Reparable item. When beyond lower level repair capability , return to depot. Condemnation and disposal not authorized below depot level.

c. *National Stock Number.* Indicates the National stock number assigned to the item and will be used for requisitioning purposes.

d. *Part Number.* Indicates the primary number used by the manufacturer (individual , company , firm , corporation , or Government activity) , which controls the design and characteristics of the item by means of its engineering drawings , specifications standards , and inspection requirements , to identify an item or range of items.

NOTE

When a stock numbered item is requisitioned , the repair part received may have a different part number than the part being replaced.

e. *Federal Supply Code for Manufacturer (FSCM).* The FSCM is a 5-digit numeric code listed in SB 708-42 which is used to identify the manufacturer , distributor , or Government agency , etc.

f. *Description.* Indicates the Federal item name and , if required , a minimum description to identify the item.

g. *Unit of Measure (U/M).* Indicates the standard of the basic quantity of the listed item as used in performing the actual maintenance function. This measure is expressed by a two-character alphabetical abbreviation (e.g. , ea , in , pr , etc.). When the unit of measure differs from the unit of issue , the lowest unit of issue that will satisfy the required units of measure will be requisitioned.

h. *Quantity Incorporated in Unit.* Indicates the quantity of the item used in the breakout shown on the illustration figure , which is prepared for a functional group , subfunctional group , or an assembly.

4. Special Information

The following publications pertain to AN/TCC-65 and its components:

TM 11-5805-201-12	Telephone Set TA-312/PT.
TM 11-5805-367-25P/2	Multiplexer TD-204/U.
TM 11-5805-367-25P/5	Converter , Telephone Signal CV-1548/G , CV-1548A/G and 18A4 Panel Assembly.
TM 11-5805-382-12	Multiplexers TD-660/G and TD-660A/G.
TM 11-5805-383-12	Multiplexer TD-754/G.
TM 11-5810-232-12P	Communications Security Equipment TSEC/KG-27.
TM 11-5830-221-24P	Intercommunications Station LS-147C/FI.

5. How to Locate Repair Parts

a. When National stock number or part number is unknown:

(1) *First.* Using the table of contents , determine the functional group within which the repair part belongs. This is necessary since illustrations are prepared for functional groups , and listings are divided into the same groups.

(2) *Second.* Find the illustration covering the functional group to which the repair part belongs.

(3) *Third.* Identify the repair part on the illustration and note the illustration figure and item number of the repair part.

(4) *Fourth.* Using the Repair Parts Listing , find the figure and item number noted on the illustration.

b. When National stock number or part number is known:

(1) *First.* Using the Index of National Stock Numbers and Part Numbers , find the pertinent National stock number or part number. This index is in ascending NIIN sequence followed by a list of part numbers in ascending alphameric sequence , cross-referenced to the illustration figure number and item number.

(2) *Second.* After finding the figure and item number , locate the figure and item number in the repair parts list.

6. Abbreviations

Not applicable.

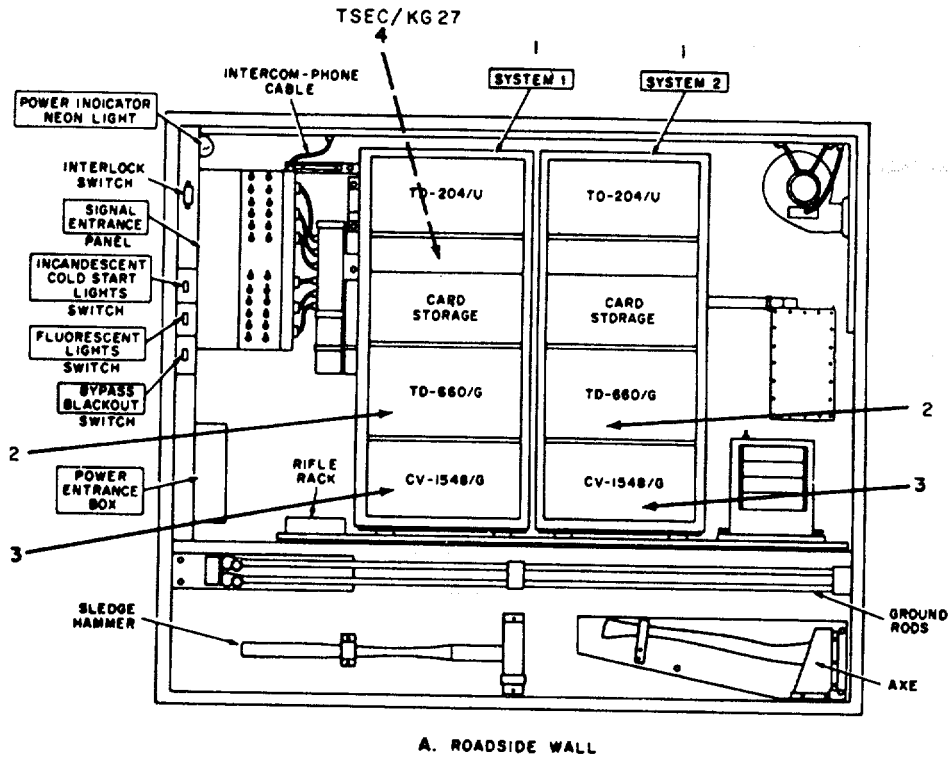

A. ROADSIDE WALL

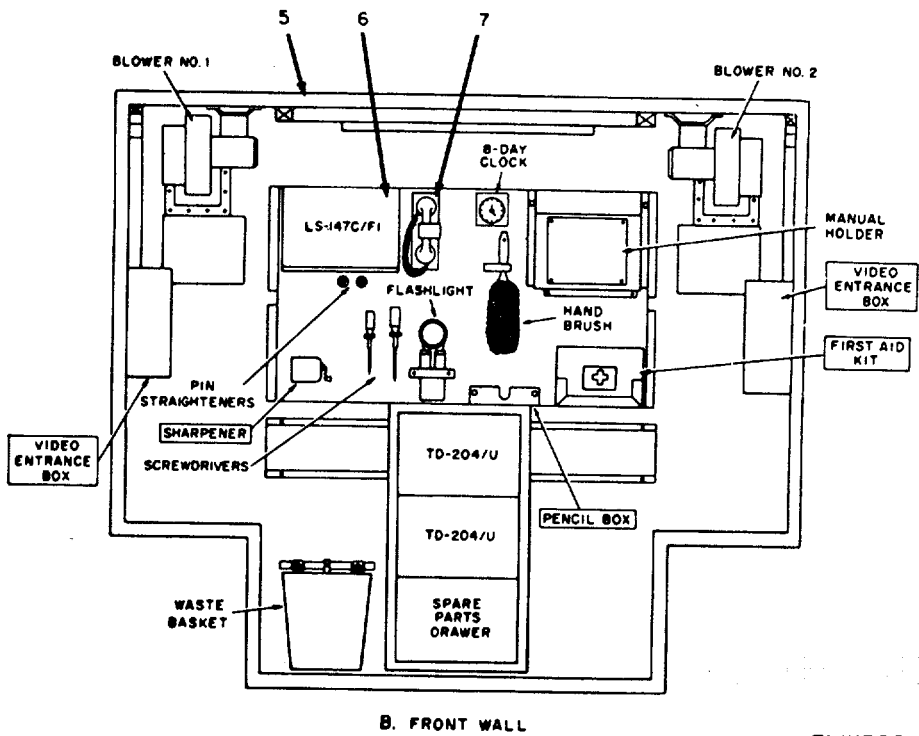

B. FRONT WALL

ELIXROOI

Figure 1. Telephone Terminal AN/TCC-65.

SECTION II

TM 11-5805-371-20P

(1) ILLUSTRATION		(2)	(3)	(4)	(5)	(6)	(7)	(8)
(a) FIG NO.	(b) ITEM NO.	SMR CODE	NATIONAL STOCK NUMBER	PART NUMBER	FSCM	DESCRIPTION <i>USABLE ON CODE</i>	U/M	QTY INC IN UNIT
						GROUP 00 TELEPHONE TERMINAL AN/TCC-65		
1	1	PDDDD	5805-00-900-8200	TD204U	80058	MULTIPLEXER OR	EA	1
1	1	PDDDD	5820-00-930-8078	TD754G	80058	MULTIPLEXER	EA	1
1	2	PDDDD	5820-00-930-8079	TD660G	80058	MULTIPLEXER OR	EA	1
1	2	PDDDD	5820-00-928-3382	TD660AG	80058	MULTIPLEXER	EA	1
1	3	PDDDD	5805-00-069-8795	CV1548G	80058	CONVERTER , TELEPHONE SIGNAL	EA	1
1	4	PDDDD		TSECKG27	80063	KEY GENERATOR , ELECTRONIC	EA	1
1	5	XDOFF		S333TCC65	80058	SHELTER , ELECTRICAL EQUIPMENT OR	EA	1
1	5	XDOFF	5410-00-460-7382	S333ATCC65	80058	SHELTER , ELECTRICAL EQUIPMENT	EA	1
1	6	PDFDD	5830-00-752-5357	LS14CFI	80058	INTERCOMMUNICATION STATION	EA	1
1	7	PDDDD	5805-00-543-0012	TA312	80058	TELEPHONE SET	EA	1

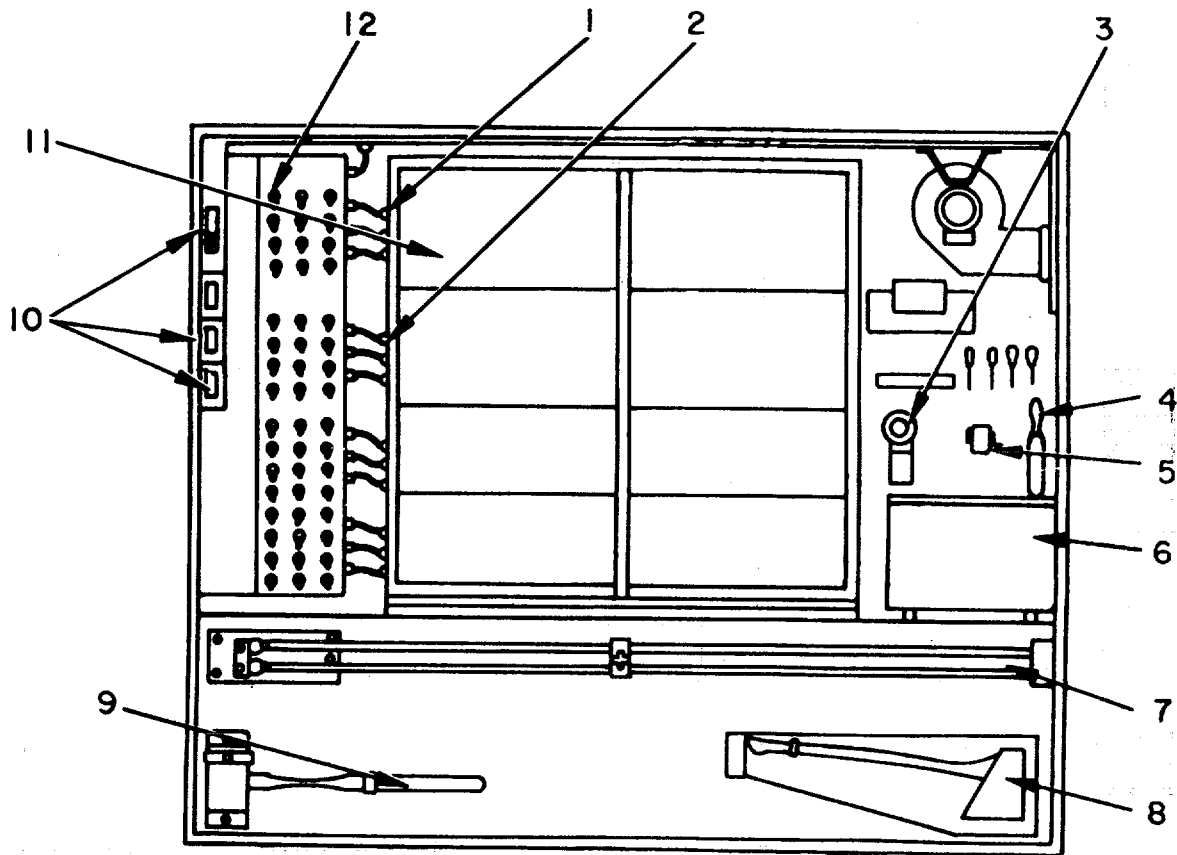

(SERIAL NOS. 20 AND ABOVE)

ELIXR002

Figure 2. Shelter , Facility S-333/TCC-65 , roadside wall.

SECTION II

TM 11-5805-371-20P

(1) ILLUSTRATION		(2)	(3)	(4)	(5)	(6)	(7)	(8)
(a) FIG NO.	(b) ITEM NO.	SMR CODE	NATIONAL STOCK NUMBER	PART NUMBER	FSCM	DESCRIPTION <i>USABLE ON CODE</i>	U/M	QTY INC IN UNIT
						GROUP 01 SHELTER , FACILITY S-333/TCC-65		
2	1	PAOZZ	5935-00-758-5250	BJ79-2	14949	CONNECTOR , PLUG , ELECTRICAL	EA	8
2	2	PAOZZ	5935-00-843-2844	UG910BU	81349	CONNECTOR, PLUG, ELECTRICAL	EA	8
2	3	PAOZZ	6150-00-495-1214	SCB539492	80063	LANTERN, ELECTRIC	EA	1
2	4	PAOZZ	5805-00-342-4521	SCC539469	80063	BRUSH, DUSTING BENCH	EA	1
2	5	PAOZZ	7520-00-162-6178	SCC539503	80063	SHARPENER, PENCIL	EA	1
2	6	PAOZZ	7910-00-900-1678	2800	29335	CLEANER, VACUUM	EA	1
2	7	PAOZZ	5975-00-224-5260	MX148G	80058	ROD, GROUND	EA	1
2	8	PAOZZ	5110-00-115-5049	SCC539451	80063	AXE, SINGLE BIT	EA	1
2	9	PAOZZ	5120-00-900-6096	B08	17782	HAMMER, SLEDGE	EA	1
2	10	PAOZZ	5930-00-827-0034	1201	74545	SWITCH, TOGGLE	EA	3
2	11	PAOZZ	6150-00-495-1214	SCB539492	80063	LEAD, ELECTRICAL	EA	1
2	12	PAOZZ	5930-00-087-4712	8906K1384	27191	SWITCH, TOGGLE	EA	48

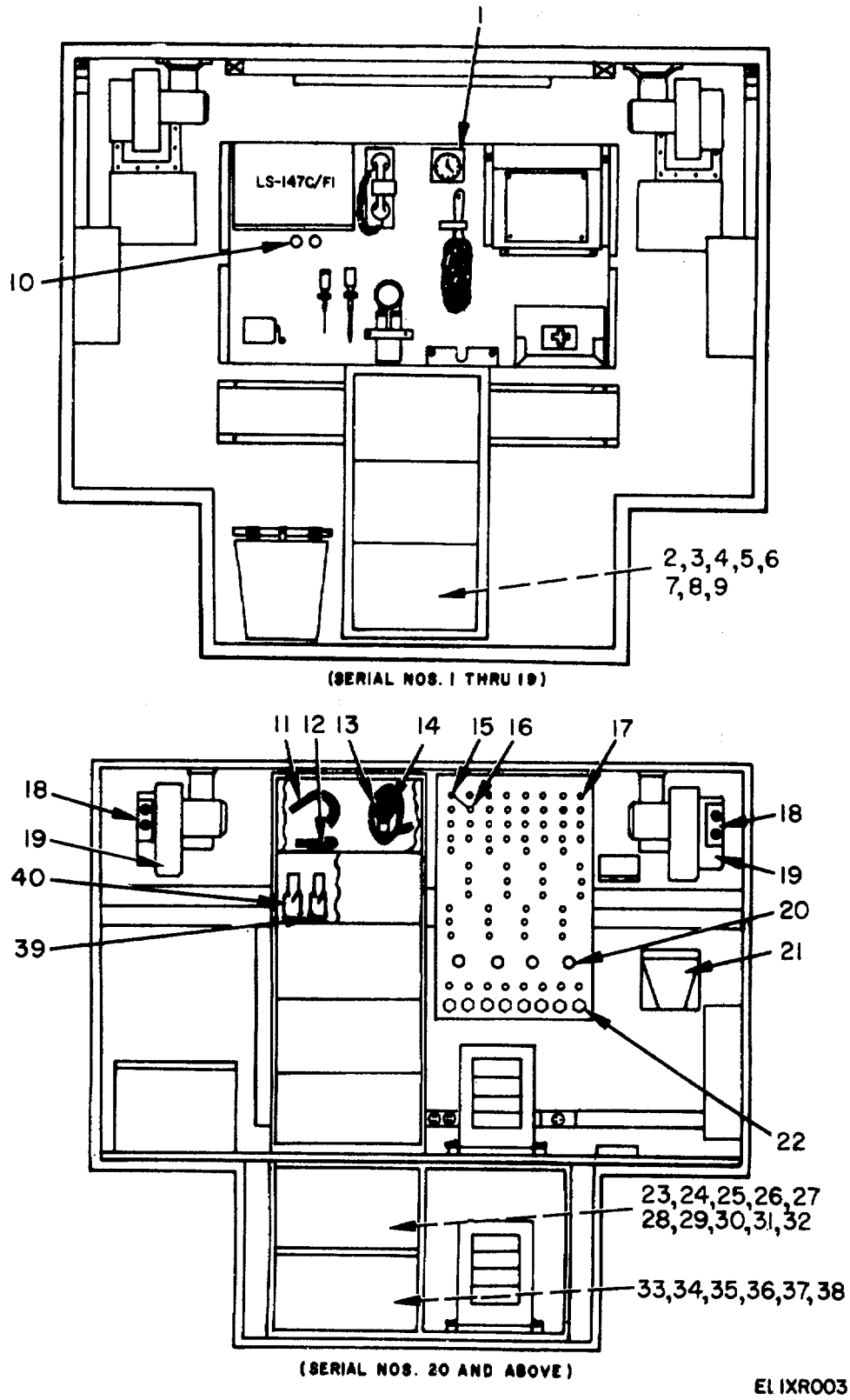

EL IXR003

Figure 3. Shelter , Facility S-333/TCC-65 , front wall.

SECTION II

TM 11-5805-371-20P

(1) ILLUSTRATION		(2)	(3)	(4)	(5)	(6)	(7)	(8)
(a) FIG NO.	(b) ITEM NO.	SMR CODE	NATIONAL STOCK NUMBER	PART NUMBER	FSCM	DESCRIPTION USABLE ON CODE	U/M	QTY INC IN UNIT
3	1	PAOHH	6645-00-410-2395	SCC539475	80063	CLOCK , ELECTRICAL , WALL MOUNTED	EA	1
3	2	PAOZZ	5935-00-064-5731	U237AG	81349	CONNECTOR , PLUG , ELECTRICAL	EA	3
3	3	PAOZZ	5935-00-105-4641	PL75	14949	CONNECTOR , PLUG , ELECTRICAL	EA	8
3	4	PAOZZ	5995-00-177-4554	SCD681112	80063	CABLE ASSEMBLY , POWER , ELECTRICAL	EA	4
3	5	PAOZZ	5995-00-177-4555	SCD681112	80063	CABLE ASSEMBLY , POWER , ELECTRICAL	EA	6
3	6	PAOZZ	5995-00-177-4556	SCD681112	80063	CABLE ASSEMBLY , POWER , ELECTRICAL	EA	2
3	7	PAOZZ	5995-00-192-9603	SCD627081GP7	80063	CABLE ASSEMBLY , RADIO FREQUENCY	EA	8
3	8	PAOZZ	5995-00-192-9607	SCD595511-1	80063	CABLE ASSEMBLY , POWER , ELECTRICAL	EA	24
3	9	PAOZZ	5995-00-192-9613	SCD627092GP1	80063	CABLE ASSEMBLY , POWER , ELECTRICAL	EA	1
3	10	PAOZZ	5120-00-293-3603	SCB539472	80063	PIN , STRAIGHTENER , ELECTRON TUBE	EA	1
3	11	PAOZZ	5120-00-946-5148	SCB539592	80063	GRIP , CABLE JAW	EA	2
3	12	PAOZZ	5120-00-946-5114	SCB539593	80063	GRIP , CABLE JAW	EA	1
3	13	PAOZZ	6230-00-115-2687	SCC539496	80063	LIGHT , EXTENSION	EA	1
3	14	PAOZZ	6240-00-155-8634	50WRS	24455	LAMP , INCANDESCENT	EA	1
3	15	PAOZZ	5935-00-930-1210	13738	91737	CONNECTOR , PLUG , ELECTRICAL	EA	20
3	16	PAOZZ	5935-00-949-5244	13739	91737	CONNECTOR , PLUG , ELECTRICAL	EA	20
3	17	PAOZZ	5935-00-259-3347	UG414AU	81349	CONNECTOR , RECEPTACLE , ELECTRICAL	EA	60
3	18	PAOZZ	5935-00-999-6934	5225	75582	SWITCH AND RECEPTACLE ASSEMBLY	EA	2
3	19	PAOZZ	6105-00-234-3504	SCD539825	80063	MOTOR , ALTERNATING CURRENT	EA	2
3	20	PAOZZ	5935-00-715-4698	PTB12-8PS	77820	CONNECTOR , RECEPTACLE , ELECTRICAL	EA	4
3	21	PAOZZ		SCC539454	80063	BASKET , WASTEPAPER	EA	1
3	22	PAOZZ	5935-00-477-1273	16532	91737	CONNECTOR , RECEPTACLE , ELECTRICAL	EA	16
3	23	PAOZZ		CW282AU	80058	COVER , ELECTRICAL CONNECTOR	EA	168
3	24	PAOZZ	5935-00-350-1834	5261	74545	CONNECTOR , RECEPTACLE , ELECTRICAL	EA	2
3	25	PAOZZ	5995-00-351-3107	SCD681007	80063	CABLE ASSEMBLY , SPECIAL PURPOSE , ELECTRICAL	EA	112
3	26	PAOZZ		UG260EU	81349	CONNECTOR , PLUG , ELECTRICAL	EA	176
3	27	PAOZZ	5935-00-484-5033	BTG6B12-3S	09922	CONNECTOR , PLUG , ELECTRICAL	EA	12
3	28	PAOZZ	6145-00-683-5353	RG71BU	80058	CABLE , RADIO FREQUENCY	EA	1
3	29	PAOZZ		WT26U	80058	CABLE , POWER , ELECTRICAL	EA	1
3	30	PAOZZ	5935-00-813-4720	MS3114E14-19P	96906	CONNECTOR , RECEPTACLE , ELECTRICAL	EA	12
3	31	PAOZZ	5935-00-817-3373	PT06E12-8PSR	77820	CONNECTOR , PLUG , ELECTRICAL	EA	4
3	32	PAOZZ	5935-00-817-3385	PT06E12-8SSR	77820	CONNECTOR , PLUG , ELECTRICAL	EA	8
3	33	PAOZZ	5935-00-843-7362	UP121M	81349	CONNECTOR , PLUG , ELECTRICAL	EA	12
3	34	PAOZZ	5935-00-577-0237	5262	74545	CONNECTOR , RECEPTACLE , ELECTRICAL	EA	11
3	35	PAOZZ	5935-00-931-7490	UP221M	89349	CONNECTOR , PLUG , ELECTRICAL	EA	14
3	36	PAOZZ	5935-00-992-0304	PT06E10-98PSR	77820	CONNECTOR , PLUG , ELECTRICAL	EA	4
3	37	PAOZZ	5935-00-992-0304	PT06E10-98PSR	77820	CONNECTOR , PLUG , ELECTRICAL	EA	2
3	38	PAOZZ	5935-00-992-0311	PT02E10-98S	77820	CONNECTOR , RECEPTACLE , ELECTRICAL	EA	4
3	39	PAOZZ	5120-00-293-2692	SCB539548	80063	EXTRACTOR , ELECTRON TUBE	EA	1
3	40	PAOZZ	5120-00-293-2696	SCB539547	80063	EXTRACTOR , ELECTRON TUBE	EA	1

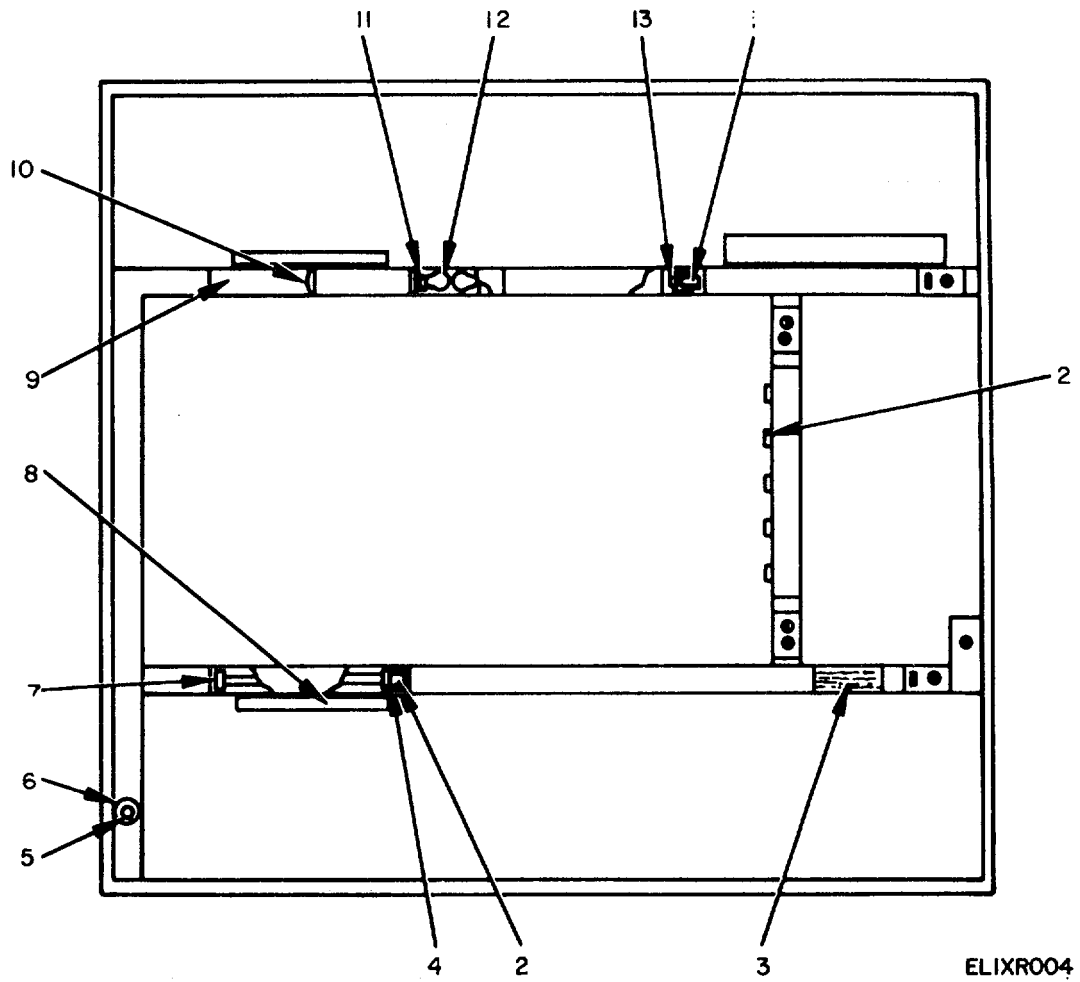

Figure 4. Shelter, Facility S-333/TCC-65, interior (Sheet 1 of 2).

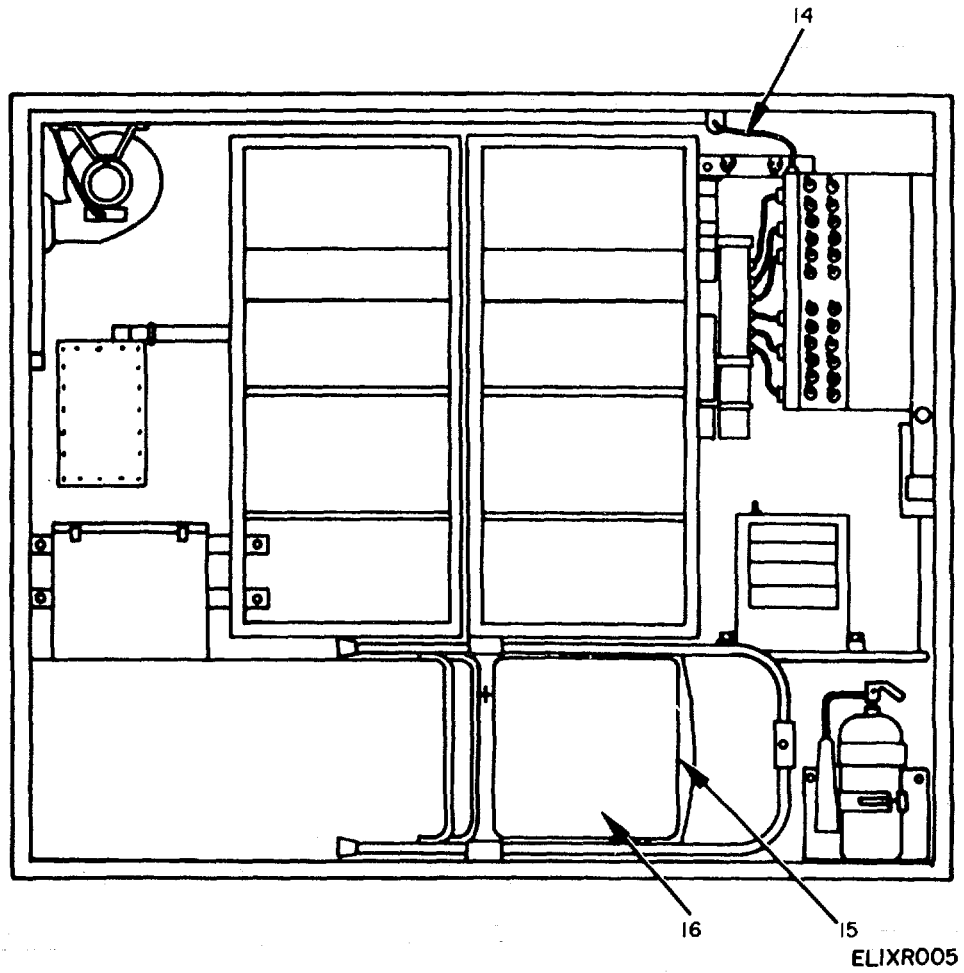
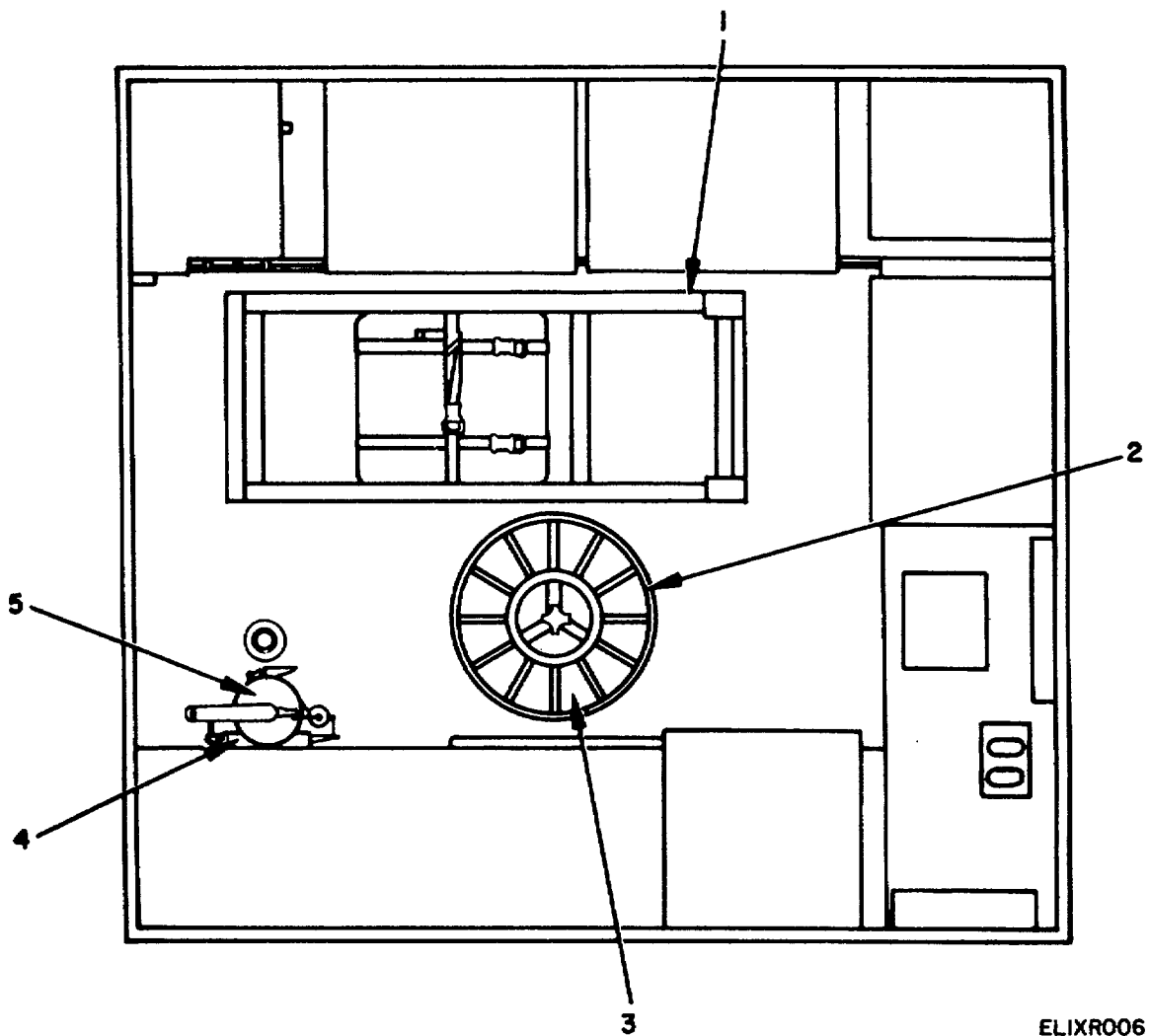

Figure 4. Shelter, Facility S-333/TCC-65, interior (Sheet 2 of 2).

SECTION II

TM 11-5805-371-20P

(1) ILLUSTRATION		(2)	(3)	(4)	(5)	(6)	(7)	(8)
(a) FIG NO.	(b) ITEM NO.	SMR CODE	NATIONAL STOCK NUMBER	PART NUMBER	FSCM	DESCRIPTION <i>USABLE ON CODE</i>	U/M	QTY INC IN UNIT
4	1	PAOZZ	6250-00-804-3449	89G457D	24457	BALLAST LAMP	EA	4
4	2	PAOZZ	6250-00-194-4794	SCB539504	80063	STARTER, FLUORESCENT LAMP	EA	4
4	3	PAOZZ	6210-00-930-1217	SCC539466-2	80063	SHIELD, INCANDESCENT	EA	2
4	4	PAOZZ	6250-00-227-0317	78X736	85599	LAMPHOLDER	EA	4
4	5	PAOZZ	6240-00-635-9753	NE34	08806	LAMP, GLOW	EA	1
4	6	PAOZZ	6250-00-299-6562	4109	74545	LAMPHOLDER	EA	1
4	7	PAOZZ	6250-00-158-7900	78X491	85599	LAMPHOLDER	EA	4
4	8	PAOZZ	6240-00-152-2996	SCC539495	80063	LAMP, FLUORESCENT	EA	4
4	9	PAOZZ	6210-00-451-8350	SCC539466-1	80063	SHIELD, FLUORESCENT LIGHT	EA	4
4	10	PAOZZ	6210-00-757-9694	P40	19634	LOCK, LAMP, FLUORESCENT	EA	8
4	11	PAOZZ	6250-00-995-9074	12-240	72619	LAMPHOLDER	EA	4
4	12	PAOZZ	6240-00-155-8653	25T78DC	08805	LAMP, INCANDESCENT	EA	4
4	13	PAOZZ	5910-00-142-4515	532943	56289	CAPACITOR, FIXED, ELECTROLYTIC	EA	2
4	14	PAOZZ	5995-00-736-0943	SCC343394GP1	80063	CABLE ASSEMBLY, TELEPHONE	EA	1
4	15	PAOZZ	7210-00-753-3043	SCC539526	80063	CUSHION, CHAIR	EA	1
4	16	PAOZZ	7105-00-269-8463	SCD53947L	80063	CHAIR, FOLDING	EA	1



ELIXR006

Figure 5. Shelter , Facility S-333/TCC-65 , floor plan.

SECTION II

TM 11-5805-371-20P

(1) ILLUSTRATION		(2)	(3)	(4)	(5)	(6)	(7)	(8)
(a) FIG NO.	(b) ITEM NO.	SMR CODE	NATIONAL STOCK NUMBER	PART NUMBER	FSCM	DESCRIPTION <i>USABLE ON CODE</i>	U/M	QTY INC IN UNIT
5	1	PAOZZ	2540-00-846-8483	HX3543G	80058	LADDER, VEHICLE, BOARDING	EA	1
5	2	PAOZZ	1130-00-656-1090	RC435U	80058	REEL, CABLE	EA	1
5	3	PAOZZ	5995-00-134-7159	CX7453AU	80058	CABLE ASSEMBLY, POWER, ELECTRICAL	EA	1
5	4	PAOZZ	4210-00-288-6B49	RB1	33525	BRACKET, FIRE EXTINGUISHER	EA	1
5	5	PAOZZ	4210-00-270-4512	SCD539482	80063	EXTINGUISHER, FIRE	EA	1

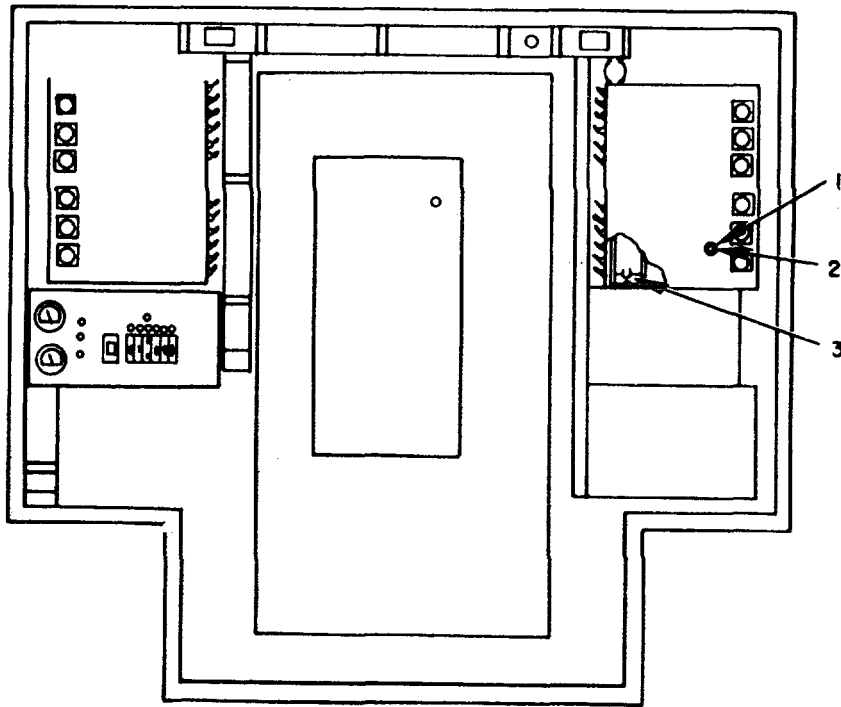

(SERIAL NOS. 1 THRU 19)

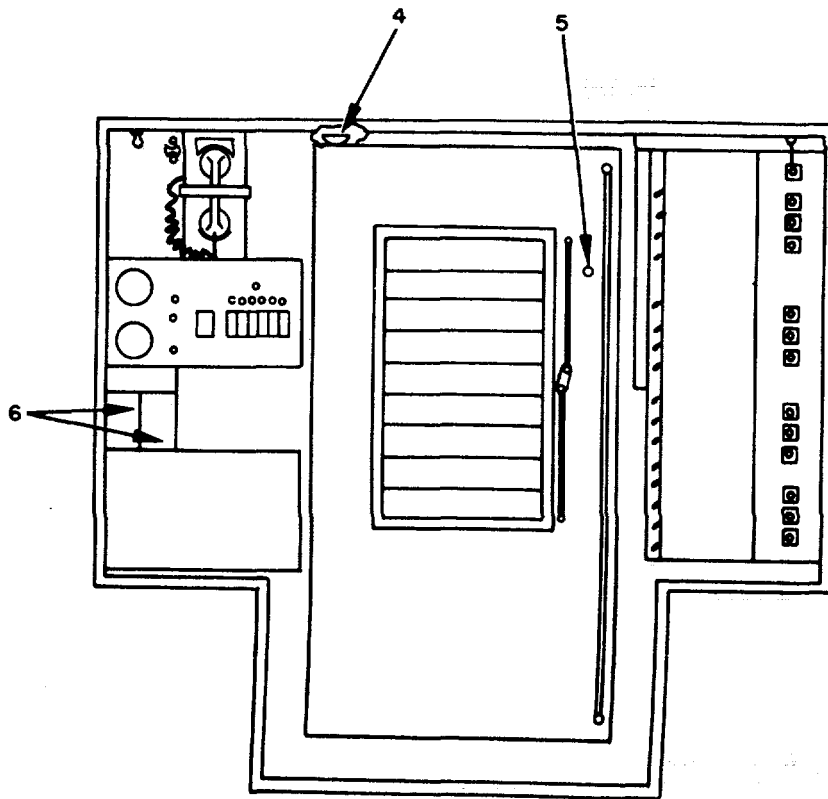

(SERIAL NOS. 20 AND ABOVE)

ELIXR007

Figure 6. Shelter, Facility S-333/TCC-65 , rear wall.

SECTION II

TM 11-5805-371-20P

(1) ILLUSTRATION		(2)	(3)	(4)	(5)	(6)	(7)	(8)
(a) FIG NO.	(b) ITEM NO.	SMR CODE	NATIONAL STOCK NUMBER	PART NUMBER	FSCM	DESCRIPTION <i>USABLE ON CODE</i>	U/M	QTY INC IN UNIT
6	1	PAOZZ	5940-00-283-5386	U106U	81349	POST, BINDING	EA	212
6	2	PAOZZ	5970-00-869-6263	SCC76202-1	80063	CAP, ELECTRICAL	EA	212
6	3	PAOZZ	5935-00-045-9832	U187AU	81340	CONNECTOR, RECEPTACLE, ELECTRICAL	EA	4
6	4	PAOZZ	5915-00-909-7762	SP289	81831	FILTER. POWER	EA	2
6	5	PAOZZ	5930-00-636-3160	8Z2RW822A2	91929	SWITCH. SENSITIVE	EA	1
6	6	PAOZZ	5340-00-930-1476	CB101	23404	VIEWER DOOR	EA	1

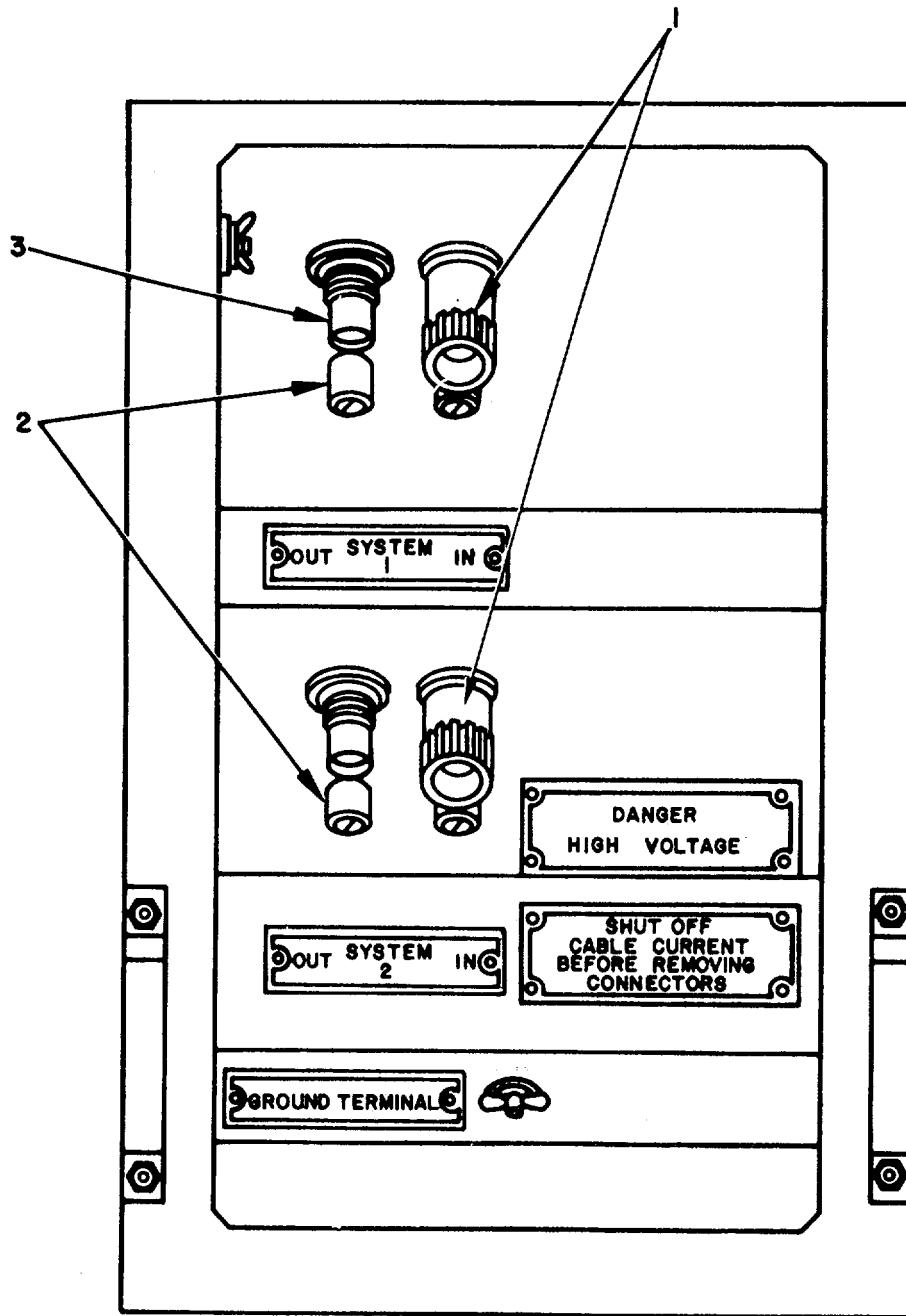

(SERIAL NOS. 1 THRU 19)

ELIXR008

Figure 7. Shelter , Facility S-333/TCC-65 , video entrance box (Sheet 1 of 2).

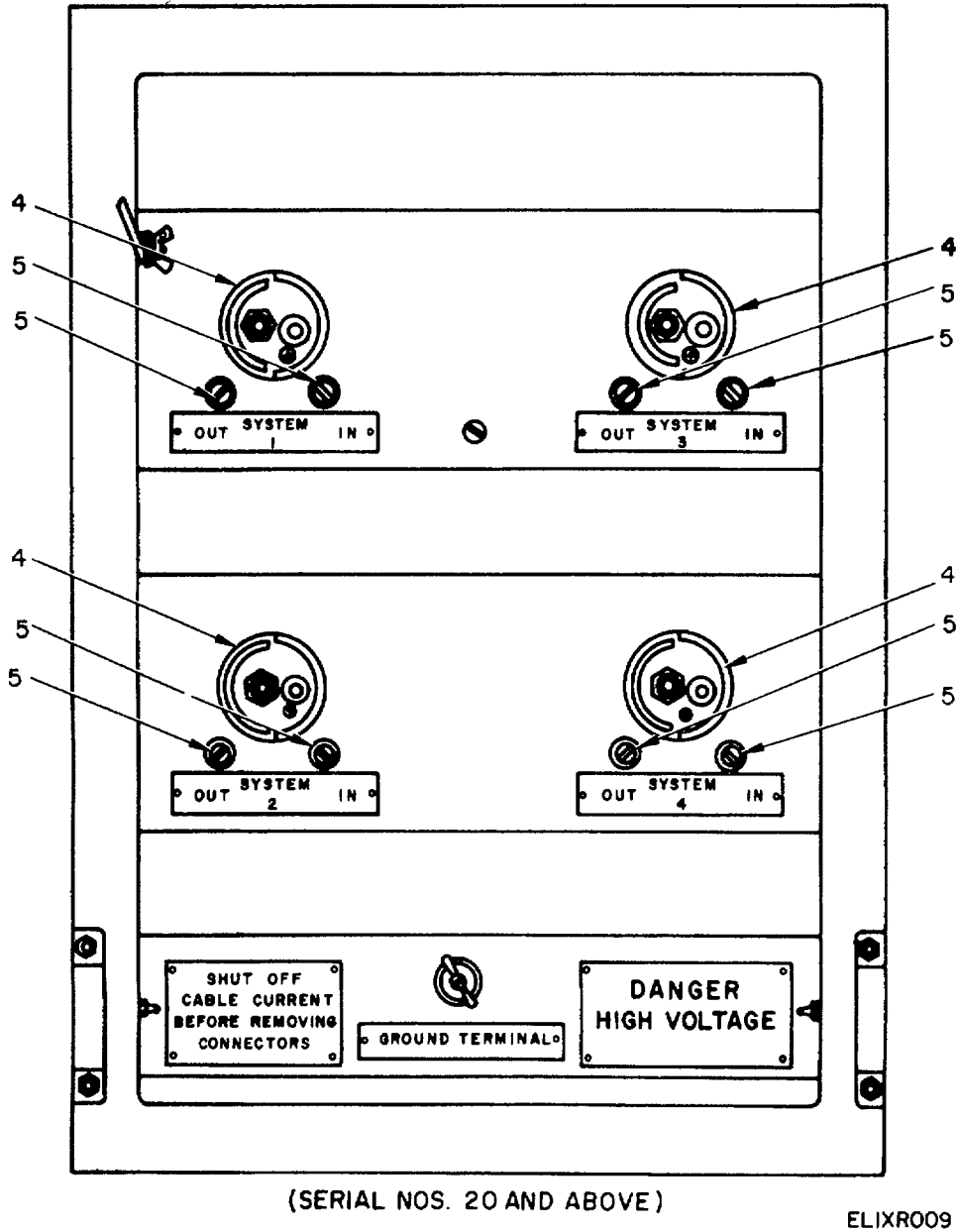
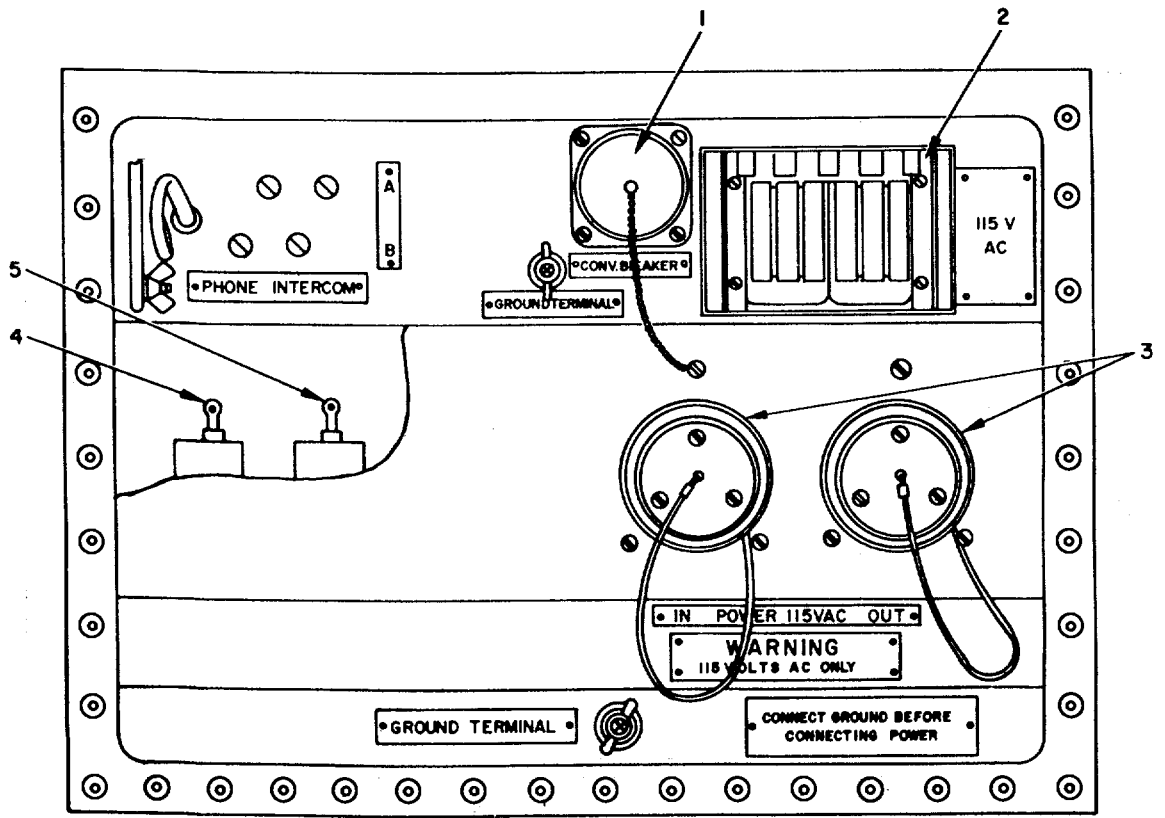

Figure 7. Shelter, Facility S-333/TCC-65 , video entrance box (Sheet 2 of 2).

SECTION II

TM 11-5805-371-20P

(1) ILLUSTRATION		(2)	(3)	(4)	(5)	(6)	(7)	(8)
(a) FIG NO.	(b) ITEM NO.	SMR CODE	NATIONAL STOCK NUMBER	PART NUMBER	FSCM	DESCRIPTION <i>USABLE ON CODE</i>	U/M	QTY INC IN UNIT
7	1	PAOZZ	5935-00-946-1272	ESC194240GP2	80063	CONNECTOR, RECEPTACLE, ELECTRICAL	EA	4
7	2	PAOZZ	5920-00-930-2307	SC8547223	80063	ARRESTOR, LIGHTING	EA	4
7	3	PAOZZ	5935-00-947-2925	ESC194239GP2	80063	CONNECTOR, RECEPTACLE	EA	4
7	4	PAOZZ	5935-00-449-7747	UG1837U	81349	CONNECTOR, RECEPTACLE, ELECTRICAL	EA	4
7	5	PAOZZ	5920-00-930-2307	SC8547223	80063	ARRESTOR, LIGHTING	EA	8



ELIXROIO

Figure 8. Shelter, Facility S-333/TCC-65 , power entrance box.

SECTION II

TM 11-5805-371-20P

(1) ILLUSTRATION		(2)	(3)	(4)	(5)	(6)	(7)	(8)
(a) FIG NO.	(b) ITEM NO.	SMR CODE	NATIONAL STOCK NUMBER	PART NUMBER	FSCM	DESCRIPTION <i>USABLE ON CODE</i>	U/M	QTY INC IN UNIT
8	1	PAOZZ	5925-00-681-4952	MS25244-10	96906	CIRCUIT BREAKER	EA	1
8	2	PAOZZ	5975-00-947-3068	NS3780FS	21873	COVER, RECEPTACLE, ELECTRICAL	EA	1
8	3	PAOZZ	5935-00-064-5732	U2388U	81349	CONNECTOR, RECEPTACLE, ELECTRICAL	EA	2
8	4	PAOZZ	5915-00-946-5369	JW17-1122	56289	FILTER, RADIO INTERFERENCE	EA	4
8	5	PAOZZ	5915-00-116-8916	591B	02777	FILTER, RADIO INTERFERENCE	EA	4

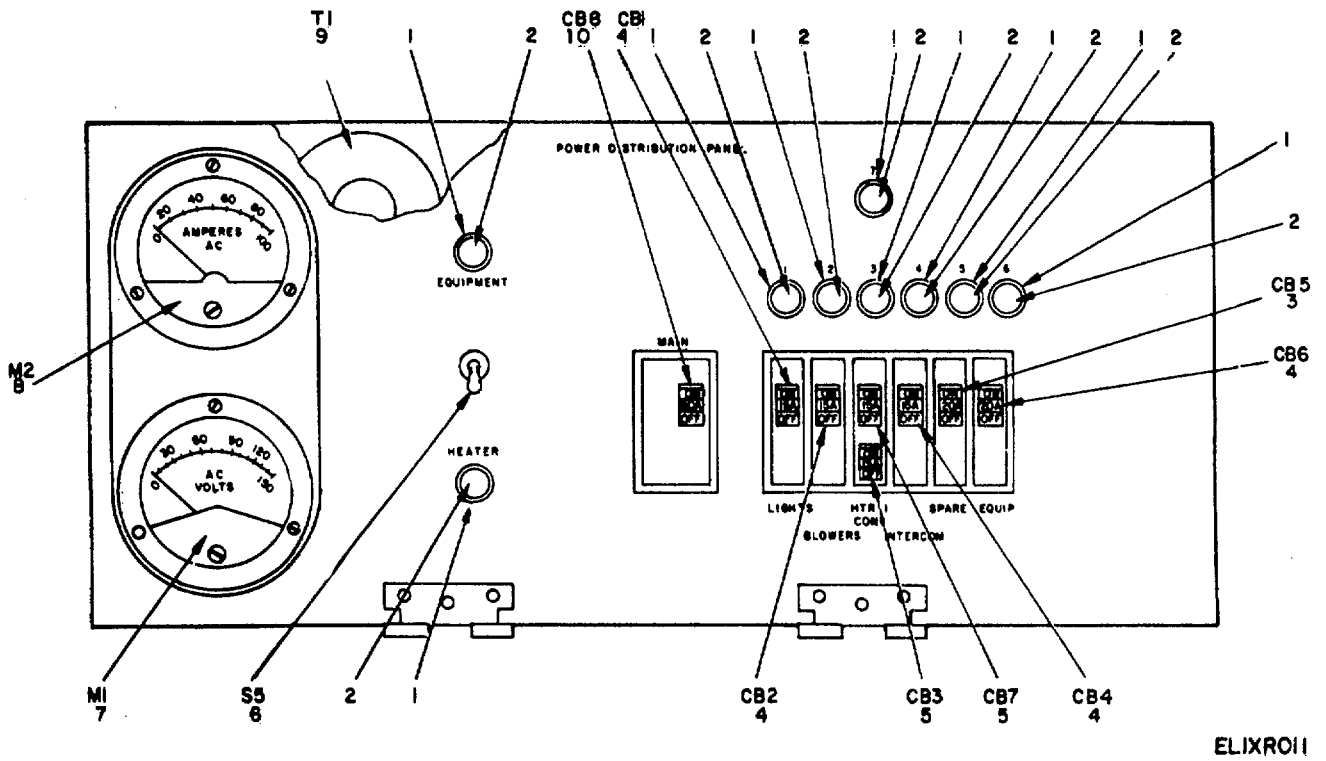
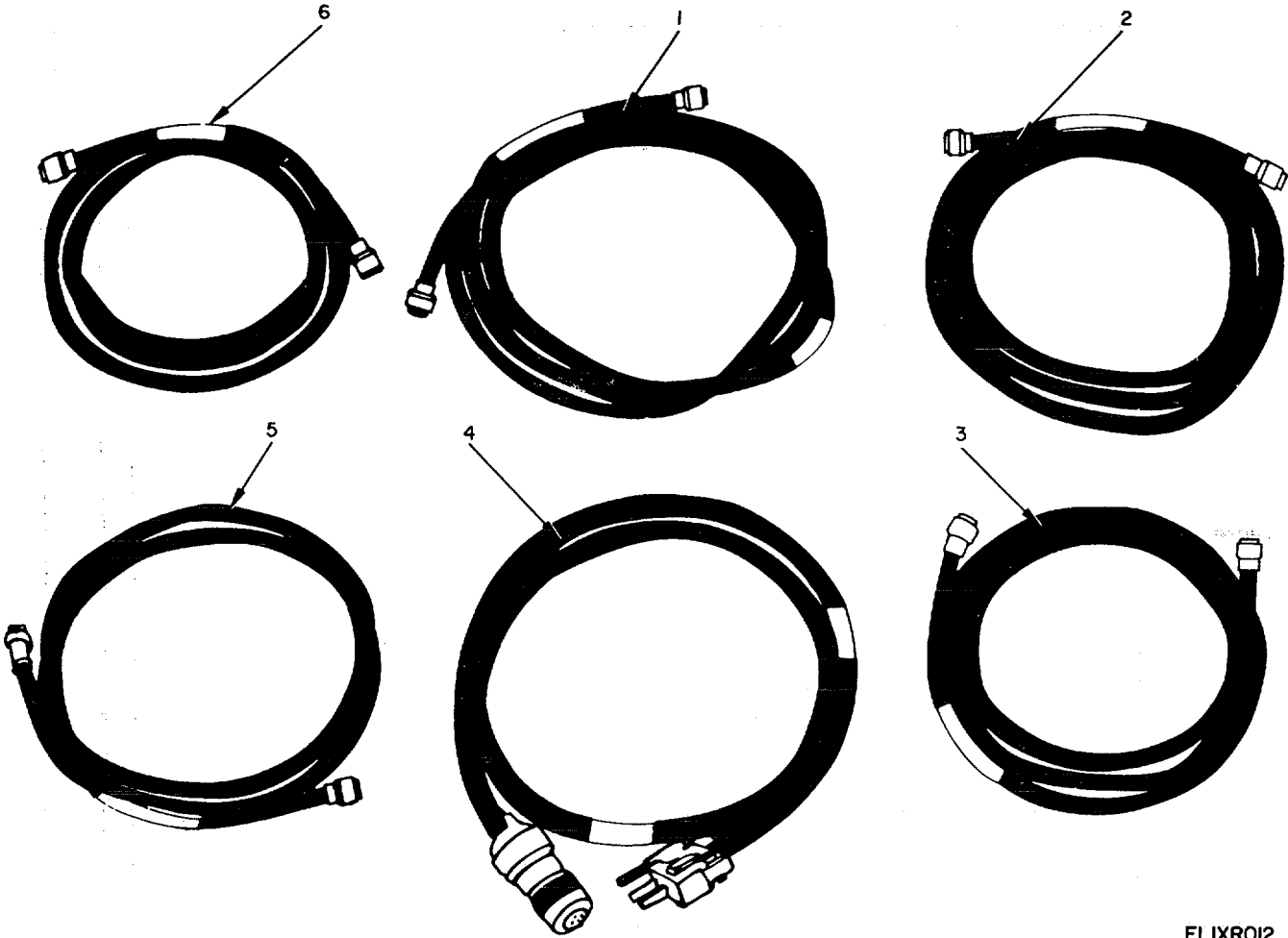

Figure 9. Shelter, Facility S-333/TCC-65, power distribution panel.

SECTION II

TM 11-5805-371-20P

(1) ILLUSTRATION		(2)	(3)	(4)	(5)	(6)	(7)	(8)
(a) FIG NO.	(b) ITEM NO.	SMR CODE	NATIONAL STOCK NUMBER	PART NUMBER	FSCM	DESCRIPTION <i>USABLE ON CODE</i>	U/M	QTY INC IN UNIT
9	1	PAOZZ	6210-00-087-4248	37-0408-0331-245	72619	LIGHT. INDICATOR	EA	9
9	2	PAOZZ	6240-00-223-9100	NE51	08806	LAMP, GLOW	EA	9
9	3	PAOZZ	5925-00-583-7941	Q0-120	56365	CIRCUIT BREAKER	EA	1
9	4	PAOZZ	5925-00-818-4811	Q0-115	56365	CIRCUIT BREAKER	EA	4
9	5	PAOZZ	5925-00-815-6657	Q0-1515	56365	CIRCUIT BREAKER	EA	2
9	6	PAOZZ	5930-00-543-8394	MS25103-23	96906	SWITCH, TOGGLE	EA	1
9	7	PAOZZ	6625-00-669-5019	MR36W150ACVVR	81349	VOLTMETER	EA	1
9	8	PAOZZ	6625-00-854-6787	MR36WIOACAAR	81349	AMMETER	EA	1
9	9	PAOZZ	5950-00-892-8208	3CT118	93993	TRANSFORMER, CURRENT	EA	1
9	10	PAOZZ	5925-00-703-6084	Q0-250	56365	CIRCUIT BREAKER	EA	1



ELIXR012

Figure 10. Kit, Installation.

SECTION II

TM 11-5805-371-20P

(1) ILLUSTRATION		(2)	(3)	(4)	(5)	(6)	(7)	(8)
(a) FIG NO.	(b) ITEM NO.	SMR CODE	NATIONAL STOCK NUMBER	PART NUMBER	FSCM	DESCRIPTION <i>USABLE ON CODE</i>	U/M	QTY INC IN UNIT
						GROUP 0401 INSTALLATION KIT , TSEC/KG-27		
10	1	PAOZZ	5995-00-181-9545	SCD693658GR9	80063	CABLE ASSEMBLY, RADIO FREQUENCY	EA	1
10	2	PAOZZ	5995-00-181-9545	SCD693658GR10	80063	CABLE ASSEMBLY, RADIO FREQUENCY	EA	1
10	3	XDOZZ		SCD595511GR88	80063	CABLE ASSEMBLY, RADIO FREQUENCY	EA	1
10	4	XDOZZ		SCD595511GR87	80063	CABLE ASSEMBLY, RADIO FREQUENCY	EA	1
10	5	PAOZZ	5995-00-177-4555	KG27	80058	CABLE ASSEMBLY, SHIELDED POWER	EA	1
10	6	XDOZZ		SCD595511GR86	80063	CABLE ASSEMBLY, RADIO FREQUENCY	EA	1

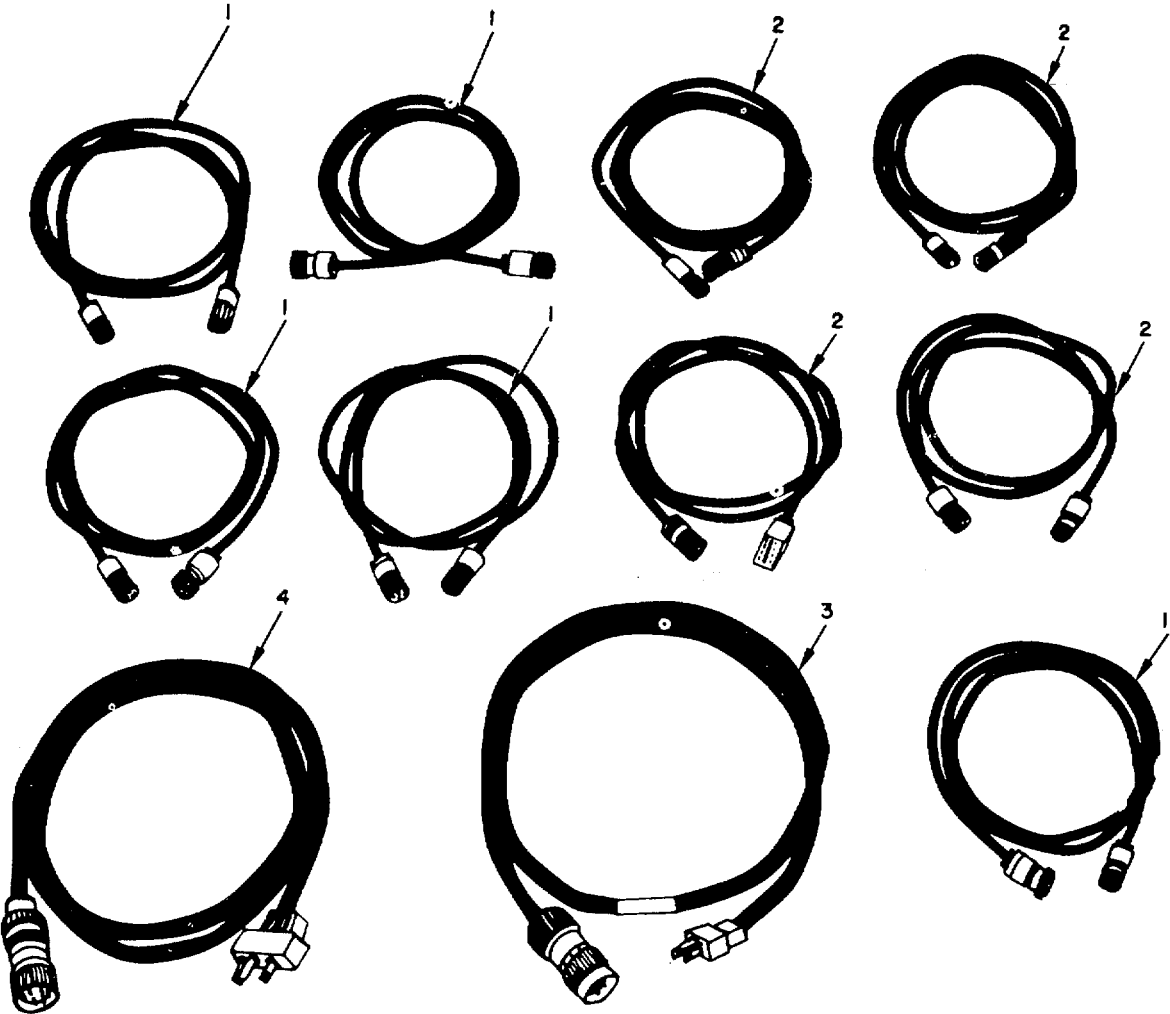

ELIXR013

Figure 11. Loop-Back Test Kit.

SECTION II

TM 11-5805-371-20P

(1) ILLUSTRATION		(2)	(3)	(4)	(5)	(6)	(7)	(8)
(a) FIG NO.	(b) ITEM NO.	SMR CODE	NATIONAL STOCK NUMBER	PART NUMBER	FSCM	DESCRIPTION <i>USABLE ON CODE</i>	U/M	QTY INC IN UNIT
						GROUP 0402 LOOP-BACK KIT , TSEC/KG-27		
11	1	PAOZZ	5995-00-177-4667	CC3419U	80058	CABLE, ASSEMBLY VIDEO	EA	5
11	2	PAOZZ	5995-00-177-4675	CG3473U	80058	CABLE ASSEMBLY, RADIO FREQUENCY	EA	4
11	3	PAOZZ	5995-00-177-4665	CX10764G	80058	CABLE, POWER SHIELDED	EA	1
11	4	PAOZZ	5995-00-935-5294	CX11729G	80058	CABLE ASSEMBLY, POWER ELECTRICAL	EA	1

NOTE: LATEST NATIONAL STOCK NUMBER AND PART NUMBER ASSIGNMENTS ARE INCLUDED AT END OF INDEX.

STOCK NUMBER	FIGURE NO.	ITEM NO.	STOCK NUMBER	FIGURE NO.	ITEM NO.
5935-00-045-9832	6	3	5805-00-543-0012	1	7
5935-00-064-5731	3	17	5930-00-543-8394	9	6
5935-00-064-5732	8	3	5925-00-583-7941	9	3
5805-00-069-8795	1	3	6240-00-635-9753	4	5
6210-00-087-4248	9	1	8130-00-656-1090	5	2
5930-00-087-4712	2	12	6625-00-669-5019	9	7
5935-00-105-4641	3	18	5925-00-681-4952	8	1
6230-00-115-2687	3	12	6145-00-683-5353	3	30
5110-00-115-5049	2	8	5925-00-703-6084	9	10
5915-00-116-8916	8	5	5935-00-715-4698	3	4
5995-00-134-7159	5	3	5995-00-736-0943	4	14
5910-00-142-4515	4	13	5830-00-752-5357	1	6
6240-00-152-2996	4	8	7213-00-753-3043	4	15
6240-00-155-8634	3	13	6210-00-757-9694	4	10
6240-00-155-8653	4	12	5935-00-758-5250	2	1
6250-00-158-8900	4	7	6250-00-804-3449	4	1
7520-00-162-6178	2	5	5935-00-813-4720	3	32
5995-00-177-4554	3	19	5925-00-815-6657	9	5
5995-00-177-4555	3	20	5935-00-817-3373	3	33
5995-00-177-4555	10	5	5935-00-817-3385	3	34
5995-00-177-4556	3	21	5925-00-818-4811	9	4
5995-00-171-4665	11	3	5930-00-827-0034	2	10
5995-00-177-4667	11	1	5935-00-843-2844	2	2
5995-00-177-4675	11	2	5935-00-843-7362	3	35
5995-00-181-9545	10	1	2540-00-846-8483	5	1
5995-00-181-9545	10	2	6625-00-854-6787	9	8
5995-00-192-9603	3	22	5970-00-869-6263	6	2
5995-00-192-9607	3	23	5950-00-892-8208	9	9
5995-00-192-9613	3	24	7910-00-900-1678	2	6
6250-00-194-4794	4	2	5120-00-900-6096	2	9
6240-00-223-9100	9	2	5805-00-900-8200	1	1
5975-00-224-5260	2	7	5915-00-909-7762	6	4
6250-00-227-0317	4	4	5820-00-928-3382	1	2
6105-00-234-3504	3	3	5935-00-930-1210	3	14
5935-00-259-3347	3	16	6210-00-930-1217	4	3
7105-00-269-8463	4	16	5340-00-930-1476	6	6
4210-00-270-4512	5	5	5920-00-930-2307	7	2
5940-00-283-5386	6	1	5920-00-930-2307	7	5
4210-00-288-6849	5	4	5820-00-930-8078	1	1
5120-00-293-2692	3	7	5820-00-930-8079	1	2
5120-00-293-2696	3	8	5935-00-931-7490	3	37
5120-00-293-3603	3	9	5995-00-935-5294	11	4
6250-00-299-6562	4	6	5935-00-946-1272	7	1
5805-00-342-4521	2	4	5120-00-946-5114	3	11
5935-00-350-1834	3	26	5120-00-946-5148	3	10
5995-00-351-3107	3	27	5915-00-946-5369	8	4
6645-00-410-2395	3	1	5935-00-947-2925	7	3
5935-00-449-7747	7	4	5975-00-947-3068	8	2
6210-00-451-8350	4	9	5935-00-949-5244	3	15
5410-00-460-7382	1	5	5935-00-992-0304	3	38
5935-00-477-1273	3	6	5935-00-992-0304	3	39
5935-00-484-5033	3	29	5935-00-992-0311	3	40
6150-00-495-1214	2	3	6250-00-995-9074	4	11
6150-00-495-1214	2	11	5935-00-999-6934	3	2

PART NUMBER	FSCM	FIG. NO.	ITEM NO.	PART NUMBER	FSCM	FIG. NO.	ITEM NO.
BD8	17782	2	9	MS3114E14-19P	96906	3	32
B79-2	14949	2	1	MS37080FS	21873	8	2
BTG6B12-3S	09922	3	29	MX148G	80058	2	7
BZ2RW822A2	91929	6	5	MX3543G	80058	5	1
CB101	23404	6	6	NE34	08806	4	5
CC3419U	80058	11	1	NE51	08806	9	2
CG3473U	80058	11	2	PL75	14949	3	18
CV1548G	80058	1	3	PTB12-8PS	77820	3	4
CW282AU	80058	3	25	PT02E10-98S	77820	3	40
CX10764G	80058	11	3	PT06E10-98PSR	77820	3	38
CX11729G	80058	11	4	PT06E10-98PSR	77820	3	39
CX7453AU	80058	5	3	PT06E12-8PSR	77820	3	33
ESC194239GP2	80063	1	3	PT06E12-8SSR	77820	3	34
ESC194240GP2	80063	7	1	P40	19634	4	10
JW17-1122	56289	8	4	QO-115	56365	9	4
KG27	80058	10	5	QO-120	56365	9	3
LS147CFI	80058	1	6	QO-1515	56365	9	5
MR36W100ACAAR	81349	9	8	QO-250	56365	9	10
MR36W150ACVVR	81349	9	7	RB1	33525	5	4
MS25103-23	96906	9	6	RC435U	80058	5	2
MS25244-10	96906	8	1	RG71BU	80058	3	30

PART NUMBER	FSCM	FIG. NO.	ITEM NO.	PART NUMBER	FSCM	FIG. NO.	ITEM NO.
SCB539472	80063	3	9	S333ATCC65	80058	1	5
SCB539492	80063	2	3	S333TCC65	80058	1	5
SCB539492	80063	2	11	TA312	80058	1	7
SCB539504	80063	4	2	TD204U	80058	1	1
SCB539547	80063	3	8	TD660AG	80058	1	2
SCB539548	80063	3	7	TD660G	80058	1	2
SCB539592	80063	3	10	TD754G	80058	1	1
SCB539593	80063	3	11	TSECKG27	80063	1	4
SCB547223	80063	7	2	UG1837U	81349	7	4
SCB547223	80063	7	5	UG260EU	81349	3	28
SCC343394GP1	80063	4	14	UG414AU	81349	3	16
SCC539451	80063	2	8	UG910BU	81349	2	2
SCC539454	80063	3	5	UP121M	81349	3	35
SCC539466-1	80063	4	9	UP221M	81349	3	37
SCC539466-2	80063	4	3	U106U	81349	6	1
SCC539469	80063	2	4	U187AU	81349	6	3
SCC539475	80063	3	1	U237AG	81349	3	17
SCC539495	80063	4	8	U238BU	81349	8	3
SCC539496	80063	3	12	WT26U	80058	3	31
SCC539503	80063	2	5	12-240	72619	4	11
SCC539526	80063	4	15	1201	74545	2	10
SCC76202-1	80063	6	2	13738	91737	3	14
SCD539471	80063	4	16	13739	91737	3	15
SCD539482	80063	5	5	16532	91737	3	6
SCD539825	80063	3	3	25T8DC	08805	4	12
SCD595511-1	80063	3	23	2800	29335	2	6
SCD595511GR86	80063	10	6	3CT118	93993	9	9
SCD595511GR87	80063	10	4	37-0408-0331-245	72619	9	1
SCD595511GR88	80063	10	3	4109	74545	4	6
SCD627081GP7	80063	3	22	50WRS	24455	3	13
SCD627092GP1	80063	3	24	5225	75582	3	2
SCD681007	80063	3	27	5261	74545	3	26
SCD681112	80063	3	19	5262	74545	3	36
SCD681112	80063	3	20	591B	02777	8	5
SCD681112	80063	3	21	78X491	85599	4	7
SCD693658GR10	80063	10	2	78X736	85599	4	4
SCD693658GR9	80063	10	1	89G457D	24457	4	1
SP289	81831	6	4	8906K1384	27191	2	12
S32943	56289	4	13				

LATEST NATIONAL STOCK NUMBER ASSIGNMENTS

STOCK NUMBER	FIGURE NO.	ITEM NO.
5935-00-577-0237	3	34
5930-0-636-3160	6	5

By Order of the Secretary of the Army:

FRED C. WEYAND
General, United States Army
Chief of Staff

Official:

PAUL T. SMITH
 Major General, United States Army
 The Adjutant General

Distribution:

Active Army:

USASA (2)	USAERDAW (1)
COE (1)	Installations (2) except
TSG (1)	Fort Gordon (10)
USAARENBD (1)	Fort Huachuca (10)
DARCOM (1)	Fort Carson (5)
TRADOC (2)	Ft Richardson (ECOM Ofc) (2)
ARADCOM (2)	Fort Gillem (10)
ARADCOM Rgn (2)	LBAD (14)
OS Maj Comds (4)	SAAD (30)
LOGCOMDS (3)	TOAD (14)
MICOM (2)	SHAD (3)
TECOM (2)	Sig FLDMS (1)
USACC (4)	USAERDAA (1)
MDW (1)	Units org under fol TOE: (1)
Armies (2)	7
Corps (2)	11-35
HISA (Ft Monmouth) (33)	11-85
Svc Colleges (1)	11-86
USASESS (10)	11-87
USAADS (2)	11-97
USAFAS (2)	11-98
USAARMS (2)	11-117
USAIS (2)	11-127
USAES (2)	11-500(AA-AC)
USAINTCS (3)	17
MAAG (1)	29-35
USARMIS (1)	29-134
	29-136

NG: None.

USAR: None.

For explanation of abbreviations used, see AR 310-50

RECOMMENDED CHANGES TO EQUIPMENT TECHNICAL PUBLICATIONS



SOMETHING WRONG WITH PUBLICATION

FROM: (PRINT YOUR UNIT'S COMPLETE ADDRESS)

DATE SENT

PUBLICATION NUMBER

PUBLICATION DATE

PUBLICATION TITLE

BE EXACT PIN-POINT WHERE IT IS

PAGE NO.	PARA-GRAPH	FIGURE NO.	TABLE NO.

IN THIS SPACE, TELL WHAT IS WRONG AND WHAT SHOULD BE DONE ABOUT IT.

PRINTED NAME, GRADE OR TITLE AND TELEPHONE NUMBER

SIGN HERE

This fine document...

Was brought to you by me:



[Liberated Manuals -- free army and government manuals](#)

Why do I do it? I am tired of sleazy CD-ROM sellers, who take publicly available information, slap “watermarks” and other junk on it, and sell it. Those masters of search engine manipulation make sure that their sites that sell free information, come up first in search engines. They did not create it... They did not even scan it... Why should they get your money? Why are not letting you give those free manuals to your friends?

I am setting this document FREE. This document was made by the US Government and is NOT protected by Copyright. Feel free to share, republish, sell and so on.

I am not asking you for donations, fees or handouts. If you can, please provide a link to liberatedmanuals.com, so that free manuals come up first in search engines:

<A HREF=<http://www.liberatedmanuals.com/>>Free Military and Government Manuals

- Sincerely
Igor Chudov
<http://igor.chudov.com/>
- [Chicago Machinery Movers](#)