

**\*TM 1-1510-218-CL**

**TECHNICAL MANUAL**

**Operator's and Crewmember's Checklist**

**ARMY C-12C AIRCRAFT**

**NSN 1510-01-070-3661**

**ARMY C-12D AIRCRAFT**

**NSN 1510-01-087-9129**

**ARMY C-12T AIRCRAFT**

**NSN 1510-01-470-0220**

DISTRIBUTION STATEMENT A: Approved  
for public release; distribution is unlimited.

\*This manual supersedes TM 55-1510-218-CL  
dated 22 April 1985.

**HEADQUARTERS  
DEPARTMENT OF THE ARMY  
04 September 2001**

## GENERAL INFORMATION AND SCOPE

### SCOPE

This checklist contains the operator's and crewmember's checks to be accomplished during normal and emergency operations.

### GENERAL INFORMATION

This checklist consists of two parts, Part I for the C-12C and the C-12D model aircraft and Part II for the C-12T1 and C-12T2 model aircraft. Both Parts I and II consist of three parts: normal procedures, emergency procedures, and performance data. Normal procedures consist of the procedures required for normal flight. Emergency procedures are subdivided into seven classifications as follows: engine, propeller, fire, fuel, electrical, landing and ditching, and flight controls. Performance data consists of performance checks.

This checklist, printed from CD, must be printed on 4 1/2" x 8" paper and assembled in a checklist binder. This manual must be carried with the aircraft at all times. Users are authorized to remove those parts that are not applicable to their aircraft model and are not required to carry them on the aircraft.

#### NOTE

**This checklist does not replace the amplified version of the procedures in the operator's manual, TM 1-1510-218-10, but is a condensed version of each procedure.**

### NORMAL PROCEDURES PAGES

The normal procedures checklist is a condensed version of the amplified checklist appearing in the normal procedures or crew duties portion of the applicable operator's manual.

## EMERGENCY PROCEDURES PAGES

The requirements for this section of the condensed checklist manual (CL) are identical to those for the normal procedures, except that the information is drawn from the amplified checks in the emergency procedures portion of the operator's manual. The emergency requirements are subdivided into the seven classifications listed in the General Information paragraph. Immediate actions are underlined and shall be memorized.

## PERFORMANCE PAGES

The contents of the performance checks procedures of this manual are a detailed version of the procedure from the Normal Procedures pages designated by a ★. The detailed procedures in the performance checklist are the same as those annotated with a ★ in the amplified normal procedures checklist in the operator's manual. The condensed normal procedures checklist has only the title of the procedure annotated with a ★, which indicates that the detailed procedure is included in the performance checklist.

## TM 1-1510-218-CL

### Symbols Preceding Numbered Steps:

- N — Indicates performance of step is mandatory for night flights.
- I — Indicates a mandatory check for instrument flights.
- O — Indicates if installed.
- ★ — Indicates a detailed procedure for this step is included in the performance checks section, located at the back of the checklist.
- \* ¾ Indicates performance of step is mandatory for all through flights. During the through flight walk-around inspection, refer to TM 1-1510-218-10 for the specific items to be inspected.

Immediate action emergency items are underlined.

## REPORTING ERRORS AND RECOMMENDING IMPROVEMENTS

You can help improve this checklist. If you find any mistakes or if you know of a way to improve the procedures, please let us know. Mail your letter, DA Form 2028 (Recommended Changes to Publications and Blank Forms) or DA Form 2028-2 directly to: Commander, US Army Aviation and Missile Command, ATTN: AMSAM-MMC-ma-np, Redstone Arsenal, AL 35898-5230. A reply will be furnished to you. You may also send your comments electronically to our e-mail address, [2028@redstone.army.mil](mailto:2028@redstone.army.mil) or by fax 256-842-6546/ DSN 788-6546.

## OZONE DEPLETING CHEMICAL INFORMATION

This document has been reviewed for the presence of Class I ozone depleting chemicals. In the base document dated 25 April 1985, all references to Class I ozone depleting chemicals have been removed from this document by substitution with chemicals that do not cause atmospheric ozone depletion.

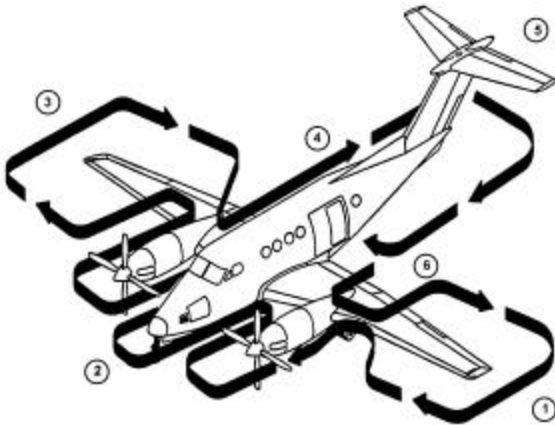

*Exterior Walkaround Diagram*

**TM 1-1510-218-CL**  
**TABLE OF CONTENTS**

**Part I C-12C and C-12D Aircraft..... N-0**

Normal Procedures ..... N-1 - N-14

Emergency Procedures ..... E-1 - E-20

Performance Checks ..... P-1 - P-14

**Part II C-12T1 and C-12T2 Aircraft..... N-0**

Normal Procedures ..... N-1 - N-14

Emergency Pocedures ..... E-1 - E-18

Performance Checks ..... P-1 - P-12

**TM 1-1510-218-CL**

**OPERATOR'S AND  
CREWMEMBER'S CHECKLIST**

**PART I**

**ARMY C-12C AIRCRAFT**

**NSN 1501-01-070-3661**

**ARMY C-12D AIRCRAFT**

**NSN 1510-01-087-9129**

## NORMAL PROCEDURES

### BEFORE EXTERIOR CHECK

- \*1. Forms/publications – Check.
- \*2. Oxygen system – Check.
- \*3. Flight controls – Unlocked and checked.
- \*4. Parking brake – Set.
- \*5. Manual trim – Zero.
- \*6. **GEAR – DN.**
- 7. **ICE VANE** handles – As desired.
- 8. Key lock switch – **ON.**
- 9. Battery switch – **ON.**
- 10. Lighting and Heats – Check.
- 11. Fuel gauges – Check fuel quantity and gauge operation.
- 12. Battery switch – **OFF.**
- 13. Galley power switches – **OFF.**
- 14. Electric toilet – Check.
- 15. Emergency equipment – Check.

### FUEL SAMPLE

- 1. Fuel sample – Check.

### LEFT WING, AREA 1

- 1. Left wing area – Check.
- 2. Left main landing gear – Check.



## **TM 1-1510-218-CL**

3. Left engine and propeller – Check.
4. Left wing center section – Check.
5. Fuselage underside – Check.

### **NOSE SECTION, AREA 2**

1. Nose section – Check.

### **RIGHT WING, AREA 3**

1. Right wing center section – Check.
2. Right engine and propeller – Check.
3. Right main landing gear – Check.
4. Right wing – Check.

### **FUSELAGE RIGHT SIDE, AREA 4**

1. Fuselage right side – Check.

### **EMPENNAGE, AREA 5**

1. Empennage – Check.

### **FUSELAGE LEFT SIDE, AREA 6**

1. Fuselage left side – Check.
- \*2. Chocks and tiedowns – Check removed.

### **INTERIOR CHECK**

1. Cargo/loose equipment – Check secure.
2. Cabin door – Locked and checked.
3. Cargo door – Locked and checked. 

## TM 1-1510-218-CL

4. Emergency exit – Check.
- ★ 5. Crew/passenger briefing – As required.

### BEFORE STARTING ENGINES

- \*1. Oxygen system – Set.
2. Circuit breakers – Check.
- \*3. Overhead panel – Check.
- \*4. Fuel panel switches – Check.
5. Magnetic compass – Check.
6. **CLOCK** and **MAP** lights – **OFF**.
- \*7. Pedestal controls – Set.
8. Lower console switches – Set.
9. Gear alternate engage and ratchet handles – Stowed.
10. Free air temperature gauge – Check.
11. Pilot's instrument panel – Check and set.
12. Copilot's instrument panel – Check and set.
13. Subpanel – Check and set.
- ★ 14. Fuel pumps/crossfeed operation – Check.
- \*15. GPU – As required.
- \*16. **EXTERNAL POWER** advisory light – As required.
- \*17. Battery switch – **ON**.
18. Annunciator panels – Test.
- ★ 19. Stall and gear warning system – Check.
20. Engine fire protection system – Check.

## FIRST ENGINE START (BATTERY START)

1. **EXTERIOR LIGHTS** switches – As required.
2. Propeller – Clear.
3. Engine – Start.
4. Engine and systems instruments – Check.
5. **CONDITION** lever – **HIGH IDLE**. Monitor **TGT** as the condition lever is advanced.
6. **GEN** switch – **RESET**, then **ON**.

## SECOND ENGINE START (BATTERY START)

1. First engine generator load 50% or less – **GEN** switch **OFF**.
2. Propeller – Clear.
3. Engine – Start.
4. Engine and systems instruments – Check.
5. **BATTERY CHARGE** light on – Check.
6. **INVERTER** switches – **ON**, check, **INVERTER** lights **OFF**.
7. Second engine generator switch – **RESET**, then **ON**.
8. **CONDITION** levers – As required.
9. Red anticollision light – Reset.

## TM 1-1510-218-CL

### ABORT START

1. **CONDITION** lever – **FUEL CUTOFF**.
2. **IGNITION AND ENGINE STARTER** switch – **STARTER ONLY**.
3. **TGT** – Monitor for drop in temperature.
4. Ignition and engine starter switch – **OFF** after **TGT** is below 750 °C.

### ENGINE CLEARING

1. **CONDITION** lever – **FUEL CUTOFF**.
2. **IGNITION AND ENGINE STARTER** switch – **OFF** (1-minute minimum).
3. **IGNITION AND ENGINE STARTER** switch – **STARTER ONLY** (15 seconds minimum, 40 seconds maximum).
4. **IGNITION AND ENGINE STARTER** switch – **OFF**.

### FIRST ENGINE START (GPU START)

1. **EXTERIOR LIGHT** switches – As required.
2. Propeller area – Clear.
3. Engine – Start.
4. Engine and systems instruments – Check.
5. **CONDITION** lever – **HIGH IDLE**. Monitor **TGT** as the condition lever is advanced.
6. GPU disconnect – As required.
7. **GEN** switch – **RESET**, then **ON**.

## TM 1-1510-218-CL

### \*SECOND ENGINE START (GPU START)

1. Propeller area – Clear.
2. Engine – Start.
3. Engine and systems instruments – Check.
4. Right **PROP** lever – **FEATHER**.
5. GPU – Disconnect.
6. Right **PROP** lever – **HIGH RPM**.
7. **INVERTER** switches – **ON**, check **INVERTER** lights **OFF**.
8. **GEN** switches – **RESET**, then **ON**.
9. **CONDITION** levers – As required.
10. Red anticollision light – Reset.

### BEFORE TAXIING

- \*1. **BLEED AIR VALVES** – As required.
- \*2. **BRAKE DEICE** – As required.
- \*3. **CABIN TEMP MODE** and temperature switches – Set as desired.
- ★ 4. AC/DC power – Check.
- \*5. **AVIONICS MASTER POWER** switch – **ON**.
- \*6. Avionics controls – As required.
- ★ 7. Electric elevator trim, autopilot/flight director operation **C D1** – Check as required.
- ★ 8. Autopilot trim fail system **C D1** – Check.
- ★ 9. Automatic flight control system **D2** – Check as required.

## TM 1-1510-218-CL

10. Electric elevator trim **D2** – Check.
11. Ground Proximity Altitude Advisory System (GPAAS) – Check.
12. Avionics – Check and set as required.
13. Flaps – Check.
14. Altimeters – Set and checked.

### \*TAXIING

1. Brakes – Check.
2. Flight instruments – Check for normal operation.

### ENGINE RUNUP

1. Parking break – As required.
2. Propeller feathering – Check.
- ★ 3. **AUTOFEATHER/AUTO IGNITION** – Check.
- ★ 4. Overspeed governors and rudder boost – Check.
- ★ 5. Primary governors – Check.
- ★ 6. Ice vanes – Check.
7. **CONDITION** levers – **HIGH IDLE**.
8. **POWER** levers – **IDLE**.
- ★ 9. Anti-ice and deice systems – Check.
- ★ 10. Pneumatic system – Check.
- ★\* 11. Pressurization system – Check.
12. **CONDITION** levers – As required.

### \*BEFORE TAKEOFF

1. **AUTOFEATHER** switch – **ARM**.

## TM 1-1510-218-CL

2. **BLEED AIR VALVES** – As required.
3. **FUEL** panel – Check fuel quantity and switches positions.
4. Flight and engine instruments – Check for normal indications.
5. **CABIN CONTROLLER** – Set.
6. Annunciator panels – Check and note indications.
7. **PROP** levers – **HIGH RPM**.
8. **FLAPS** – As required.
9. Trim – Set.
10. Avionics – Set.
11. Flight Controls – Check.
- ★ 12. Departure briefing – Complete.
13. **CABIN SIGNS** switch – As required.

### \*LINE UP

1. **ICE & RAIN** switches – As required.
2. Altitude alerter **D2** – Check.
- 3. Transponder/TCAS/Weather Radar – As required.
4. **ENG AUTO IGN** switches – **ARM**.
5. Lights – As required.
6. **CONDITION** levers – **HIGH IDLE**.
7. Power stabilized – Check 27% minimum.

### AFTER TAKEOFF

1. **GEAR** – **UP**.

## TM 1-1510-218-CL

2. **FLAPS** (105 KIAS) – **UP**.
3. **LANDING LIGHTS** – **OFF**.
4. Climb power – Set.
5. **PROP SYNC** switch – As required.

### CLIMB

1. **YD** switch – As required.
2. Cabin pressurization – Check.
3. **AUTOFEATHER** switch – As required.
4. **BRAKE DEICE** – As required.
5. **WSHLD ANTI-ICE** – As required.
6. Wings and nacelles – Check.
- 7. **TCAS** – Set range.

### CRUISE

1. Power – Set.
2. **ICE & RAIN** switches – As required.
3. **CABIN SIGNS** switch – As required.
4. **AUXILIARY** fuel gauges – Monitor.
5. Altimeters – Check.
6. Engine instrument indications – Noted.
7. **RECOG** lights – As required.
- 8. **TCAS** – Set for en route.



## TM 1-1510-218-CL

### DESCENT – MAX RATE (CLEAN)

1. Cabin pressurization – Set.
2. **CABIN SIGNS** switch – As required.
3. **POWER** levers – **IDLE**.
4. **PROP** levers – **HIGH RPM**.
5. **GEAR** – **UP**.
6. **FLAPS** – **UP**.
7. Airspeed –  $V_{mo}$  maximum.
8. **ICE & RAIN** switches – As required.
9. **RECOG** lights – As required.

### DESCENT – MAX RATE (LANDING CONFIGURATION)

1. Cabin pressurization – Set.
2. **CABIN SIGNS** switch – As required.
3. **POWER** levers – **IDLE**.
4. **PROP** levers – **HIGH RPM**.
5. **FLAPS** – **APPROACH**.
6. **GEAR** – **DN**.
7. Airspeed – 181 KIAS maximum.
8. **ICE & RAIN** switches – As required.
9. **RECOG** lights – As required.

## TM 1-1510-218-CL

### DESCENT – ARRIVAL

1. Cabin pressurization – Set.
2. **CABIN SIGNS** switch – As required.
3. **ICE & RAIN** switches – As required.
4. **WSHLD ANTI-ICE** – As required.
5. **RECOG** lights – **ON**.
6. Radio altimeter – As required.
7. Altimeters – Set to current altimeter setting.
- 8. **TCAS** – Set as required.
- ★ 9. Arrival briefing – Complete.

### APPROACH CHECK

1. **HSI NAV SOURCE** – As required.
- 2. **TCAS** – As required.

### BEFORE LANDING

1. **CABIN SIGNS** switch – **BOTH**.
2. **PROP SYNC** switch – **OFF**.
3. **AUTOFEATHER** switch – **ARM**.
4. **BRAKE DEICE** – As required.
5. **PROP** levers – As required.
6. **FLAPS** (below 199 KIAS) – **APPROACH**.
7. **GEAR** (below 181 KIAS) – **DN**.
8. **LANDING/TAXI** lights – As required.

## TM 1-1510-218-CL

9. **CONDITION** levers – **HIGH IDLE**.
- 10. **TCAS** – Set as required.

### LANDING

1. **AP & YD** – Disengaged.
2. **GEAR DOWN** lights – Check.
3. **PROP** levers – **HIGH RPM**.

### TOUCH AND GO LANDING

1. **PROP** levers – **HIGH RPM**.
2. **FLAPS** – As required.
3. Trim – Set.
4. Power stabilized – Check 27% minimum.
5. Takeoff power – Set.

### GO AROUND

1. Power – As required.
2. **GEAR – UP**.
3. **FLAPS – APPROACH**.
4. **FLAPS (105 KIAS) – UP**.
5. **LANDING LIGHTS – OFF**.
6. Climb power – Set.
7. **YD** – As required.
8. **BRAKE DEICE – OFF**.

## AFTER LANDING

1. **CONDITION** levers – As required.
2. **ENG AUTO IGN** – **OFF**.
3. **ICE & RAIN** switches – As required.
4. **FLAPS** – As required.
5. **XPNDR** – Standby.
6. **RADAR** – Standby.
7. **LIGHTS** – As required.

## ENGINE SHUTDOWN

1. **BRAKE DEICE** – **OFF**.
2. Parking brake – Set.
3. **LANDING/TAXI** light – **OFF**.
4. **CABIN TEMP MODE** switch – **OFF**.
5. **AUTOFEATHER** switch – **OFF**.
6. **VENT** and **AFT VENT BLOWER** switches – **AUTO**.
7. **INVERTER** switches – **OFF**.
8. Battery condition – Check.
9. **TGT/ITT** – Check.
10. **CONDITION** levers – **FUEL CUTOFF**.
11. **PROP** levers – **FEATHER**.
12. **EXTERIOR LIGHTS** – Off.
13. **MASTER PANEL LIGHTS** – Off.

## TM 1-1510-218-CL

14. **AVIONICS MASTER** switch – Off.
15. **MASTER SWITCH** – Off.
16. Key lock switch – **OFF**.
17. Oxygen system – **OFF**.
18. Chocks – As required.
19. Parking break – As required.
20. Control locks – As required.

## BEFORE LEAVING AIRCRAFT

1. Wheels – Chocked.
2. Parking brake – As required.
3. Flight controls – As required.
- N** 4. **OVERHEAD FLOOD LIGHTS** – **OFF**.
5. **STANDBY PUMPS** – **OFF**.
6. Windows **C** – As required.
7. Emergency exit lock – As required.
8. Galley power switches – **OFF**.
9. Aft cabin light – **OFF**.
10. Door light – **OFF**.
11. Walk-around inspection – Complete.
12. Aircraft forms – Complete.
13. Aircraft secured – Check.

## EMERGENCY PROCEDURES

### ENGINE MALFUNCTION

#### ENGINE MALFUNCTION BEFORE $V_1$ (ABORT)

1. POWER levers – **IDLE**.
2. Braking – As required.

#### ENGINE MALFUNCTION AFTER $V_1$

1. GEAR (positive climb) – **UP**.
2. POWER – As required.
3. FLAPS (105 KIAS) – **UP**.

IF THE PROP DID NOT FEATHER, PERFORM STEP 4.

4. PROP (dead engine) – **FEATHER**.

ONCE THE PROP IS FEATHERED, PERFORM STEPS 5 THROUGH 8.

- 5. TCAS – Set **TA**.
6. **LANDING/TAXI LIGHTS** – OFF.
7. **BRAKE DEICE** – OFF.
8. Engine cleanup – Perform.

#### ENGINE MALFUNCTION DURING FLIGHT

1. Autopilot/yaw damp – Disengage.
2. POWER – As required.
3. Dead engine – Identify.

4. PROP lever (dead engine) – **FEATHER**.
5. GEAR – As required.
6. FLAPS – As required.
- 7. TCAS – Set **TA**.
8. Power – Set for single-engine cruise.
9. Engine cleanup – Perform.

### **ENGINE MALFUNCTION DURING FINAL APPROACH**

1. POWER – As required.
2. GEAR – **DN**.

### **ENGINE MALFUNCTION (SECOND ENGINE)**

1. Airspeed – As required.
2. PROP lever – As required.

### **ENGINE SHUTDOWN IN FLIGHT**

1. **POWER** lever – **IDLE**.
2. **PROP** lever – **FEATHER**.
3. **CONDITION** lever – **FUEL CUTOFF**.
4. Engine cleanup – Perform.

### **ENGINE CLEANUP**

1. **CONDITION** lever – **FUEL CUTOFF**.
2. **ENG AUTO IGN** – **OFF**.
3. **AUTOFEATHER** switch – **OFF**.
4. **GEN** switch – **OFF**.

5. **PROP SYNC** switch – **OFF**.

### **ENGINE RESTART DURING FLIGHT (USING STARTER)**

1. **CABIN AIR/TEMP MODE** switch – **OFF**.
2. Electrical load – Reduce to minimum.
3. **FIRE PULL** handle – In.
4. **POWER** lever – **IDLE**.
5. **PROP** lever – **FEATHER**.
6. **CONDITION** lever – **FUEL CUTOFF**.
7. **TGT** (operating engine) – 700 °C or less.
8. Engine – Start.
9. **GEN** switch – **RESET**, then **ON**.
10. Engine cleanup – Perform if engine restart is unsuccessful.
11. **CABIN AIR/TEMP MODE** switch – As required.
12. Electrical equipment – As required.
13. **ENG AUTO IGN** switch – **ARM**.
14. **PROP SYNC** switch – As required.
15. **POWER** – As required.

### **ENGINE RESTART DURING FLIGHT (NOT USING STARTER)**

1. **CABIN AIR/TEMP MODE** switch – **OFF**.
2. Electrical load – Reduce to minimum.
3. **GEN** switch (affected engine) – **OFF**.
4. **FIRE PULL** handle – In.



## TM 1-1510-218-CL

5. **POWER** lever – **IDLE**.
6. **PROP** lever – **HIGH RPM**.
7. **CONDITION** lever – **FUEL CUTOFF**.
8. Airspeed – 140 KIAS minimum.
9. Altitude – Below 20,000 feet.
10. **ENG AUTO IGN** switch – **ARM**.
11. **CONDITION** lever – **LOW IDLE**.
12. **TGT** – 1000° 5 seconds maximum.
13. Oil pressure – Check.
14. **GEN** switch – **RESET**, then **ON**.
15. Engine cleanup – Perform if engine restart is unsuccessful.
16. **CABIN AIR/TEMP MODE** switch – As required.
17. Electrical equipment – As required.
18. Propellers – Synchronized.
19. **POWER** – As required.

## LOW OIL PRESSURE

1. Torque – 49% maximum. Oil pressure less than 105 psi below 21,000 feet or 85 psi 21,000 feet and above.
2. Oil pressure below 60 psi. Perform engine shutdown or land as soon as practicable using minimum power to ensure safe arrival.

**CHIP DETECTOR WARNING LIGHT  
ILLUMINATED**

If a **CHIP DET** warning light illuminates and safe single-engine flight can be maintained, perform engine shutdown.

**DUCT OVERTEMP CAUTION LIGHT  
ILLUMINATED**

1. **CABIN AIR** control – In.
2. **CABIN AIR/TEMP MODE** switch – **AUTO**.
3. **CABIN AIR/TEMP** switch – Decrease.
4. **VENT BLOWER** switch – **HI**.
5. **CABIN AIR/TEMP MODE** switch – **MAN COOL**.
6. **MANUAL TEMP** switch – **DECREASE** (hold).
7. **LEFT BLEED AIR VALVE** switch – **PNEU & ENVIRO OFF**.
8. Light still illuminated (30 seconds) **LEFT BLEED AIR VALVE** switch – **OPEN**.
9. **RIGHT BLEED AIR VALVE** switch – **PNEU & ENVIRO OFF**.
10. Light still illuminated (30 seconds) **RIGHT BLEED AIR VALVE** switch – **OPEN**.

**ICE VANE FAILURE**

1. Airspeed – 160 KIAS or below.
2. **ICE VANE CONTR** circuit breaker – Pull.
3. **ICE VANE** – Operate manually.
4. Airspeed – Resume normal airspeed.

TM 1-1510-218-CL

**ENGINE BLEED AIR SYSTEM  
MALFUNCTION**

**BLEED AIR FAILURE LIGHT ILLUMINATED**

1. **BRAKE DEICE** switch – Off.
2. **TGT** and **TORQUE** – Monitor (note readings).
3. **BLEED AIR VALVE** switch – **OFF**.
4. Cabin pressurization – Check.

**EXCESSIVE DIFFERENTIAL PRESSURE**

1. Cabin pressurization controller – Select higher setting.

IF CONDITION PERSISTS:

2. Oxygen (crew and passengers) – As required.
3. **LEFT BLEED AIR VALVE** switch – **ENVIRO OFF** (light illuminated).

IF CONDITION STILL PERSISTS:

4. **RIGHT BLEED AIR VALVE** switch – **ENVIRO OFF** (light illuminated).
5. Descend – As required.

IF CONDITION STILL PERSISTS:

6. Oxygen masks – **100%** and on.
7. **CABIN PRESS** switch – **DUMP**.
8. **BLEED AIR VALVE** switches – **OPEN** (if cabin heating is required).

## **LOSS OF PRESSURIZATION (ABOVE 10,000 FEET)**

1. Crew oxygen masks – 100% and on.
2. Passenger oxygen – **ON** and checked to ensure all passengers have oxygen masks on and are receiving supplemental oxygen if required.

## **CABIN DOOR CAUTION LIGHT ILLUMINATED**

1. **CABIN SIGNS** switch – **BOTH**.
2. **BLEED AIR VALVE** switches – **ENVIRO OFF**.
3. Descend below 14,000 feet as soon as practicable.
4. Oxygen – As required.

## **SINGLE-ENGINE DESCENT/ARRIVAL**

1. **CABIN CONTROLLER** – Set.
  2. **CABIN SIGNS** switch – As required.
  3. **ICE & RAIN** switches – As required.
  4. Altimeters – Set.
  5. **RECOG/BEACON/NAV** lights – **ON**.
- ★ 6. Arrival briefing – Complete.

## **SINGLE-ENGINE BEFORE LANDING**

1. **CABIN SIGNS** switch – **BOTH**.
2. **BRAKE DEICE** – Off.
3. **PROP** lever – As required.
4. **FLAPS** (Below 199 KIAS) – **APPROACH**.

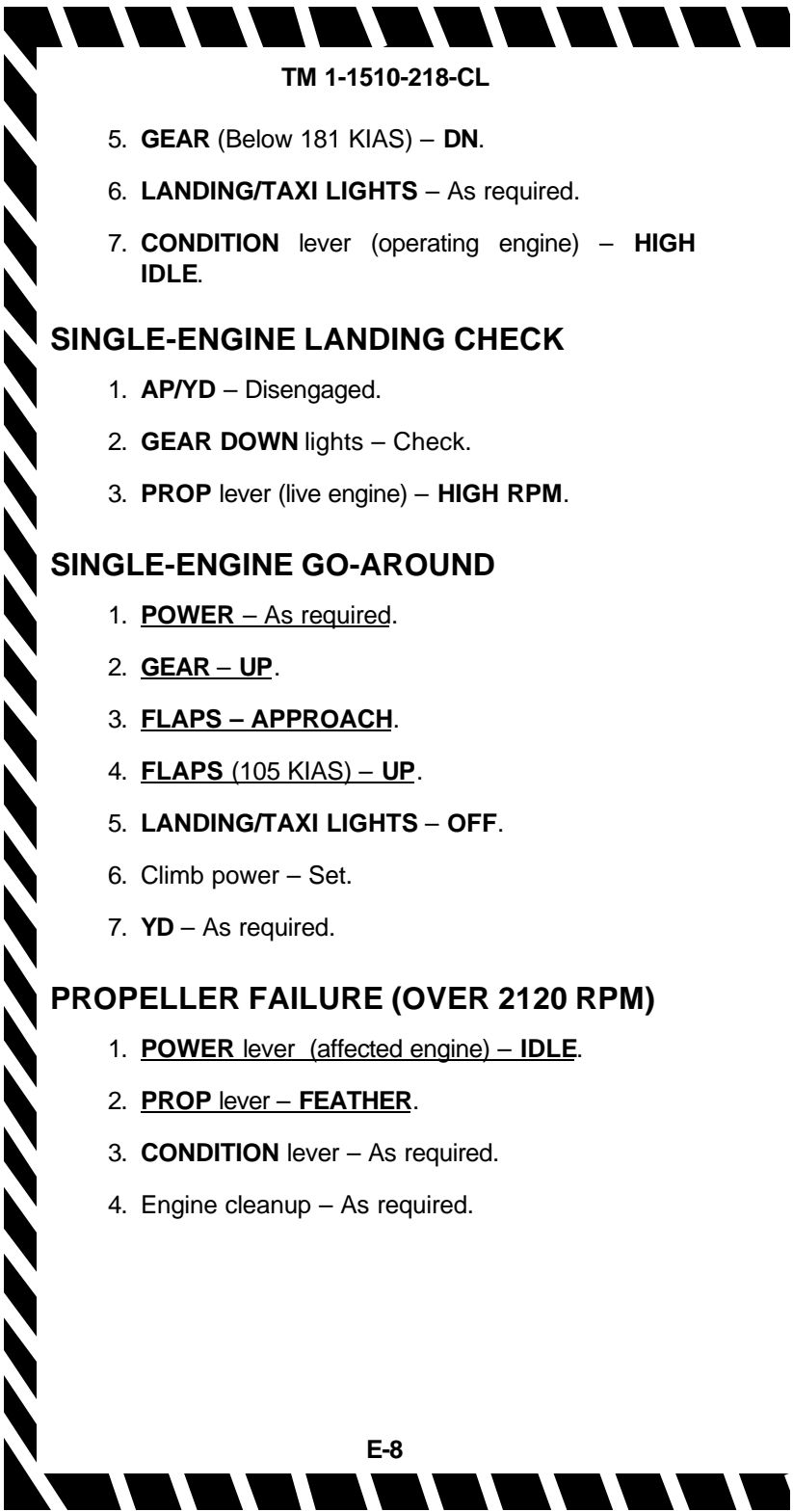

**TM 1-1510-218-CL**

5. **GEAR** (Below 181 KIAS) – **DN**.
6. **LANDING/TAXI LIGHTS** – As required.
7. **CONDITION** lever (operating engine) – **HIGH IDLE**.

**SINGLE-ENGINE LANDING CHECK**

1. **AP/YD** – Disengaged.
2. **GEAR DOWN** lights – Check.
3. **PROP** lever (live engine) – **HIGH RPM**.

**SINGLE-ENGINE GO-AROUND**

1. **POWER** – As required.
2. **GEAR – UP**.
3. **FLAPS – APPROACH**.
4. **FLAPS (105 KIAS) – UP**.
5. **LANDING/TAXI LIGHTS – OFF**.
6. Climb power – Set.
7. **YD** – As required.

**PROPELLER FAILURE (OVER 2120 RPM)**

1. **POWER** lever (affected engine) – **IDLE**.
2. **PROP** lever – **FEATHER**.
3. **CONDITION** lever – As required.
4. Engine cleanup – As required.

## **FIRE**

### **ENGINE/NACELLE FIRE DURING START OR GROUND OPERATIONS**

1. PROP levers – FEATHER.
2. CONDITION levers – FUEL CUTOFF.
3. FIRE PULL handle – Pull.
4. PUSH TO EXTINGUISH switch – Push.
5. MASTER SWITCH – OFF.

### **ENGINE FIRE IN FLIGHT (IDENTIFIED)**

1. POWER lever – IDLE.
2. PROP lever – FEATHER.
3. CONDITION lever – FUEL CUTOFF.
4. FIRE PULL handle – Pull.
5. Fire extinguisher – Actuate as required.
6. Engine cleanup – Perform.

### **FUSELAGE FIRE**

1. Fight the fire.
2. Land as soon as possible if fire continues.

### **WING FIRE**

1. Perform engine shutdown on affected side.
2. Land as soon as possible if fire continues.

## ELECTRICAL FIRE

1. Crew oxygen masks – As required.
2. Passenger oxygen – As required.
3. **MASTER SWITCH** – **OFF**. (Visual conditions only).
4. All nonessential electrical equipment – **OFF**.
5. **BATT** switch – **ON**.
6. Generator switches (individually) – **RESET**, then **ON**.
7. Circuit breakers – Check for indication of defective circuit.
8. Essential electrical equipment – **ON** (individually until fire source is isolated).
9. Land as soon as practicable.

## SMOKE AND FUME ELIMINATION

1. Crew oxygen masks – **100%** and on.
2. Passenger oxygen – **ON**.
3. **BLEED AIR VALVE** switches – **ENVIRO OFF**.
4. **VENT BLOWER** switch – **AUTO**.
5. **AFT VENT BLOWER** switch – **OFF**.
6. **CABIN AIR/TEMP MODE** switch – **OFF**.
7. If smoke and fumes are not eliminated, **CABIN PRESS** switch – **DUMP**.
8. Passenger oxygen masks – Check. Confirm that all passengers are receiving supplemental oxygen.
9. Engine oil pressure – Monitor.

## FUEL SYSTEM

### FUEL PRESS WARNING LIGHT ILLUMINATED

1. **STANDBY PUMP** switch – **ON**.
2. **FUEL PRESS** light out – Check.
3. **FUEL PRESS** light still on – Record unboosted time.

### NO FUEL TRANSFER CAUTION LIGHT ILLUMINATED

1. **AUX TRANSFER** switch (affected side) – **OVERRIDE**.
2. Auxiliary fuel quantity – Monitor.
3. **AUX TRANSFER** switch (after respective auxiliary fuel has completely transferred) – **AUTO**.

## NACELLE FUEL LEAK

1. Perform engine shutdown.
2. **FIRE PULL** handle – Pull.
3. Land as soon as practicable.

## FUEL CROSSFEED

1. **AUX TRANSFER** switches – **AUTO**.
2. **STANDBY PUMPS** – **OFF**.
3. **CROSSFEED** switch – As required.
4. **FUEL CROSSFEED** annunciator illuminated – Check.
5. **FUEL PRESS** light extinguished – Check.



6. Fuel quantity – Monitor.

### **NAC LOW LIGHT ILLUMINATED**

1. Usable fuel remaining – Confirm.
2. Land as soon as possible.

### **ELECTRICAL SYSTEM EMERGENCIES**

#### **DC GEN LIGHT ILLUMINATED**

1. **GEN** switch – **OFF**, **RESET**, then **ON**.

IF THE GENERATOR DOES NOT RESET:

2. **GEN** switch (no reset) – **OFF**.
3. Operating loadmeter – 100% maximum.

#### **BOTH DC GEN LIGHTS ILLUMINATED**

1. All nonessential equipment – Off.
2. Land as soon as practicable.

#### **EXCESSIVE LOADMETER INDICATION (OVER 100%)**

1. Loadmeter – Monitor.
2. **BATT** switch – **OFF** (monitor loadmeter).

IF LOADMETER STILL INDICATES ABOVE 100%:

3. Nonessential electrical equipment – off.

IF LOADMETER INDICATES 100% OR BELOW:

4. **BATT** switch – **ON**.

## **INVERTER LIGHT ILLUMINATED**

1. Affected **INVERTER** switch – **OFF**.

## **INST AC LIGHT ILLUMINATED**

1.  $N_1$  and TGT indications – Check.
2. Other engine instruments – Monitor.

## **CIRCUIT BREAKER TRIPPED**

1. **BUS FEEDER** breaker tripped – Do not reset.
2. Nonessential circuit – Do not reset.
3. Essential circuit – Reset once.

## **BATTERY CHARGE LIGHT ILLUMINATED**

1. Loadmeter – Check and note indication.
2. **BATT** switch – **OFF**.
3. Loadmeter – Check. If loadmeter indicates less than 2.5% change (one needle width), turn **BATT** switch **ON** and monitor for increasing load. If load continues to increase, turn **BATT** switch **OFF**.
4. **BATT** switch (landing gear/flap extension only) – **ON**.

## **AVIONICS MASTER POWER SWITCH FAILURE**

1. **AVIONICS MASTER CONTR** circuit breaker – Pull.

## **EMERGENCY DESCENT**

1. **POWER** levers – **IDLE**.
2. **PROP** levers – **HIGH RPM**.

TM 1-1510-218-CL

3. FLAPS – APPROACH.
4. GEAR – DN.
5. Airspeed – 181 KIAS maximum.

## LANDING EMERGENCIES

### LANDING GEAR UNSAFE INDICATION **C**

#### **D1**

1. LDG GEAR CONTR switch – DN.
2. LANDING GEAR RELAY and LANDING GEAR IND circuit breakers – Check in.
3. GEAR DOWN lights – Check.

IF INDICATOR REMAINS UNSAFE:

4. Landing gear emergency extension – Perform.

### LANDING GEAR UNSAFE INDICATION **D2**

1. LDG GEAR CONTROL switch – Check DN.
2. LANDING GEAR CONTROL and LANDING GEAR IND circuit breakers – Check in.
3. GEAR DOWN lights illuminated – Check.

IF INDICATOR REMAINS UNSAFE:

4. Landing gear emergency extension – Perform.

### LANDING GEAR EMERGENCY EXTENSION

#### **C D1**

1. Airspeed – 130 KIAS.
2. LANDING GEAR RELAY circuit breaker – Out.
3. LDG GEAR CONTR switch – DN.

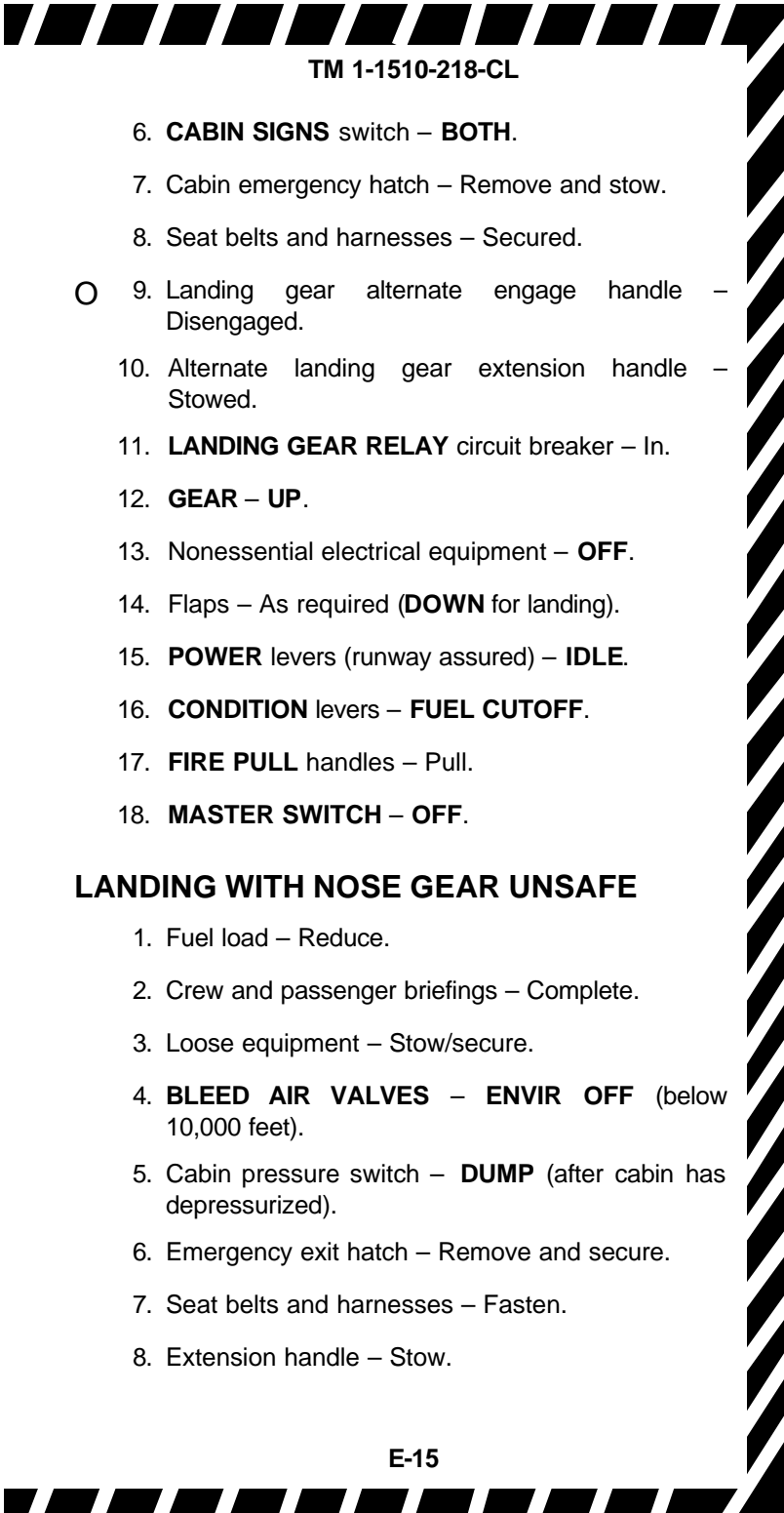

**TM 1-1510-218-CL**

4. Landing gear alternate engage handle – Lift and turn clockwise to the stop.
5. Alternate landing gear extension handle – Pump.
6. **GEAR DOWN** lights illuminated – Check.

**LANDING GEAR EMERGENCY EXTENSION**

**D2**

1. Airspeed – Below 181 KIAS.
2. **LANDING GEAR CONTR** circuit breaker – Pull.
3. **LDG GEAR CONTROL** switch – **DN**.
4. Alternate extension lever – Unstow.
5. Alternate extension lever – Pump up and down until the three green **GEAR DOWN** lights illuminate or resistance is felt.
6. Alternate extension lever – As required.

**GEAR-UP LANDING (GEAR UP OR UNLOCKED)**

1. Fuel load – Reduce.
2. Personnel emergency briefing –Completed.
3. Loose equipment – Stowed.
4. **BLEED AIR VALVES – ENVIRO OFF.**
5. **CABIN PRESS** switch – **DUMP.**
6. **CABIN SIGNS** switch – **BOTH.**
7. Cabin emergency hatch – Remove and stow.
8. Seat belts and harnesses – Secured.
- 9. Landing gear alternate engage handle – Disengaged.

## TM 1-1510-218-CL

10. Alternate landing gear extension handle – Stowed.
11. **LANDING GEAR RELAY** circuit breaker – In.
12. **GEAR – UP.**
13. Nonessential electrical equipment – **OFF.**
14. Flaps – As required (**DOWN** for landing).
15. **POWER** levers (runway assured) – **IDLE.**
16. **CONDITION** levers – **FUEL CUTOFF.**
17. **FIRE PULL** handles – Pull.
18. **MASTER SWITCH – OFF.**

## LANDING WITH NOSE GEAR UNSAFE

1. Fuel load – Reduce.
2. Crew and passenger briefings – Complete.
3. Loose equipment – Stow/secure.
4. **BLEED AIR VALVES – ENVIR OFF** (below 10,000 feet).
5. Cabin Pressure switch – **DUMP** (after cabin has depressurized).
6. Emergency exit hatch – Remove and secure.
7. Seat belts and harnesses – Fasten.
8. Extension handle – Stow.
9. **LDG GEAR CONTROL – DN.**
10. **LANDING GEAR RELAY** circuit breaker – Pull.
11. **LANDING GEAR WARN** horn circuit breaker – Pull.
12. Before landing checklist – Complete.

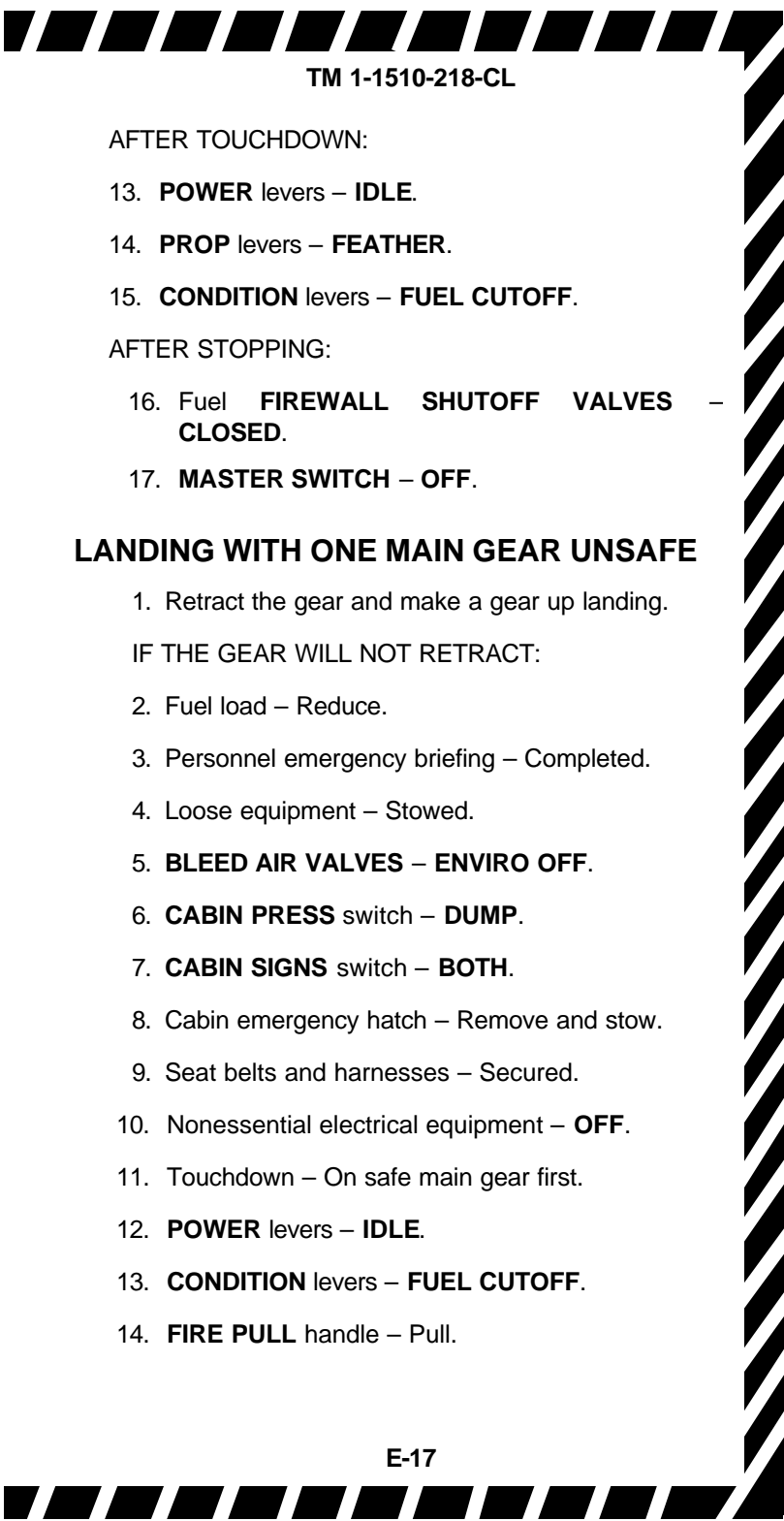

**TM 1-1510-218-CL**

AFTER TOUCHDOWN:

13. **POWER** levers – **IDLE**.
14. **PROP** levers – **FEATHER**.
15. **CONDITION** levers – **FUEL CUTOFF**.

AFTER STOPPING:

16. Fuel **FIREWALL SHUTOFF VALVES** – **CLOSED**.
17. **MASTER SWITCH** – **OFF**.

**LANDING WITH ONE MAIN GEAR UNSAFE**

1. Retract the gear and make a gear up landing.

IF THE GEAR WILL NOT RETRACT:

2. Fuel load – Reduce.
3. Personnel emergency briefing – Completed.
4. Loose equipment – Stowed.
5. **BLEED AIR VALVES** – **ENVIRO OFF**.
6. **CABIN PRESS** switch – **DUMP**.
7. **CABIN SIGNS** switch – **BOTH**.
8. Cabin emergency hatch – Remove and stow.
9. Seat belts and harnesses – Secured.
10. Nonessential electrical equipment – **OFF**.
11. Touchdown – On safe main gear first.
12. **POWER** levers – **IDLE**.
13. **CONDITION** levers – **FUEL CUTOFF**.
14. **FIRE PULL** handle – Pull.

15. **MASTER SWITCH – OFF.**

## **CRACKED WINDSHIELD**

### **INTERNAL CRACK**

1. Descend – Below 25,000 feet.
2. Cabin Pressure – Reset pressure differential to 4 psi or less within 10 minutes.

## **CRACKED CABIN WINDOW**

1. Crew oxygen masks – **100%** and on, if above 10,000 feet.
2. **CABIN SIGNS** switch – **BOTH.**
3. Passenger oxygen – **ON** and checked, if above 10,000 feet.
4. Cabin pressure – Depressurize.
5. Land as soon as practicable.

## **DITCHING**

1. Radio calls/transponder – As required.
2. Personnel emergency briefing – As required.
3. **BLEED AIR VALVES – ENVIRO OFF/PNEU ONLY.**
4. **CABIN PRESS** switch – **DUMP.**
5. **CABIN SIGNS** switch – **BOTH.**
6. Cabin emergency hatch – Remove and stow.
7. Seat belts and harnesses – Secured.
8. **GEAR – UP.**
9. **FLAPS – DN.**

**TM 1-1510-218-CL**

10. Nonessential electrical equipment – **OFF**.
11. Approach – Normal, power on.
12. Emergency lights – As required.

**FLIGHT CONTROLS MALFUNCTION**

**UNSCHEDULED      RUDDER      BOOST  
ACTIVATION**

1. **RUDDER BOOST** – **OFF**.
- IF CONDITION PERSISTS:
2. **RUDDER BOOST** circuit breaker – Pull.
  3. **BLEED AIR VALVE** – **OFF** (Below 10,000 feet).
  4. Rudder trim – Adjust.

**UNSCHEDULED      ELECTRIC      ELEVATOR  
TRIM**

1. Control wheel disconnect switch – Depress.
2. **ELEV TRIM** switch – **OFF**.
3. **ELEC TRIM** circuit breaker – **OUT**.



## PERFORMANCE CHECKS

### FIRE EXTINGUISHER PRESSURE

A gauge, calibrated in psi, is mounted on each supply cylinder for determining the level of charge and should be checked during preflight. Refer to Table P-1.

*Table P-1. Engine Fire Extinguisher Gauge Pressure*

Temp °C	-40	-29	-18	-06	04	16	20	38	48
	190	220	250	290	340	390	455	525	605
PSI	to	to	to	to	to	to	to	to	to
	240	275	315	365	420	480	550	635	730

### CREW/PASSENGER BRIEFING

1. Crew Introduction.
2. Equipment.
  - a. Personnel to include ID tags.
  - b. Professional (medical equipment, etc.).
  - c. Survival.
3. Flight Data.
  - a. Route.
  - b. Altitude.
  - c. Time en route.
  - d. Weather.
4. Normal Procedures.
  - a. Entry and exit of aircraft.

## **TM 1-1510-218-CL**

- b. Seating and seat position.
  - c. Seat belts.
  - d. Movement in aircraft.
  - e. Internal communications.
  - f. Security of equipment.
  - g. Smoking.
  - h. Oxygen.
  - i. Refueling.
  - j. Weapons and prohibited items.
  - k. Protective masks.
  - l. Toilet.
  - m. Polarized windows.
5. Emergency Procedures.
- a. Emergency exits.
  - b. Emergency equipment.
  - c. Emergency landing / ditching procedures.

## **FUEL PUMPS/CROSSFEED OPERATION**

1. **FIRE PULL** handles – Pull.
2. **STANDBY PUMP** switches – **ON**.
3. Battery Switch – **ON**.
4. **#1** and **#2 FUEL PRESS** warning lights – Illuminated.
5. **FIRE PULL** handles – In.

## TM 1-1510-218-CL

6. **#1** and **#2 FUEL PRESS** warning lights – Extinguished.
7. **STANDBY PUMP** switches – **STANDBY PUMP**.
8. **#1** and **#2 FUEL PRESS** warning lights – Illuminated.
9. **CROSSFEED** – Check. Check system operation by activating switch momentarily left then right, noting that **#1** and **#2 FUEL PRESS** warning lights extinguish and that the **FUEL CROSSFEED** advisory light illuminates as switch is energized.
10. **BATT** switch – **OFF** (GPU start).

## STALL AND GEAR WARNING SYSTEM

1. **STALL WARN TEST** switch – **TEST**. Check that warning horn sounds.
2. **LDG GEAR WARN TEST** switch – **TEST**. Check that warning horn sounds and that the two **LDG GEAR CONTR** handle warning lights illuminate.

## AC/DC POWER

1. AC frequency – 394 – 406 Hz.
2. AC voltage – 104 – 124 Vac.
3. DC load – 85% maximum per generator.
4. DC voltage – 28 – 28.5 Vdc.

## ELECTRIC ELEVATOR TRIM, AUTOPILOT , FLIGHT DIRECTOR OPERATION **C** **D1**

1. Pilot and copilot **PITCH TRIM** switches – Press to **NOSE UP** and **NOSE DN** positions, singularly and in pairs. Check that trim wheel moves in proper direction and operates only when trim switches are pressed in pairs. Any deviation requires that electric elevator trim be turned off and flight conducted using only manual trim.
2. **DISC TRIM** switch – Press to second detent and verify that electric trim disconnects and that **ELEC TRIM** light extinguishes.
3. Flight Director (FD) and Radio Magnetic Indicator (RMI) warning flags masked – Check.

### NOTE

Since the pressure of airflow that normally opposes movement of control surfaces is absent during preflight check, it is possible to get a hard over control surface deflection if an autopilot command is allowed to remain active for any appreciable length of time. Move turn knob and pitch thumbwheel only enough to check operation, then return them to the center position.

4. Select HDG mode – Check.
5. Horizontal Situation Indicator (**HSI**) heading marker under lubber line and vertical needle centered – Set.
6. Engage autopilot and check controls stiff – Check.
7. Move **HSI** heading marker 10° left and right and verify that FD and control wheels respond in the appropriate direction – Check.

## TM 1-1510-218-CL

8. Press **AP/YD** disengage switch to first detent and verify that autopilot disengages and flight controls are free – Check.
9. Elevator Trim – Check on.
10. Engage autopilot – Check.
11. Command 5° trim **UP** with **AP** pitch wheel and verify that manual trim wheel moves nose **UP** and **AP** trim light indicates **UP** trim – Check.
12. Press **PITCH TRIM** switch **NOSE DN** and verify that autopilot disengages and **AUTO PILOT TRIM FAIL** and **MASTER WARNING** lights illuminate – Check.

### NOTE

**The AP TRIM FAIL annunciator will extinguish by pressing the AP/YD disconnect button on the control wheel to the first detent.**

13. Engage autopilot – Check.
14. Move **HSI** heading marker to command a bank on FD – Check.
15. Press go-around switch and verify that **GA** light illuminates, autopilot disengages, and that FD commands a wings level, 7° nose-up attitude - Check.
16. Press **TEST** switch (pilot's HSI) and verify that attitude display indicates an additional 10° pitch up and 20° right bank – Check.

## AUTOPILOT TRIM FAIL SYSTEM **C D1**

1. Engage autopilot command **DN** with **AP** pitch wheel and engage **AUTO PILOT TRIM TEST** switch when elevator trim wheel starts to rotate.

## TM 1-1510-218-CL

2. Verify that autopilot disengages and **AP TRIM FAIL** and **MASTER WARNING** lights illuminate within 10 seconds.

## AUTOMATIC FLIGHT CONTROL SYSTEM **D2**

1. Altitude alert.

### NOTE

**Pause a few seconds after each step to allow time for the proper indications.**

- a. Set alert controller more than 1000 feet above altitude indicated on pilot's altimeter. The pilot's altimeter alert light should be extinguished.
  - b. Decrease the alert controller to within 1000 feet of the pilot's altimeter setting. The alert light should illuminate.
  - c. Decrease the controller to less than 250 feet above the pilot's altimeter setting. The alert light should extinguish.
  - d. Increase the controller to  $300 \pm 50$  feet above the pilot's altimeter indication and check that the alert light illuminates.
  - e. Set the desired altitude.
2. Autopilot.
    - a. Autopilot controller **UP TRIM**, **DN TRIM** annunciators – Check not illuminated.

### **CAUTION**

**A steady illumination of UP TRIM or DN TRIM annunciator indicates that the automatic synchronization is not functioning and the autopilot should not be engaged.**

## TM 1-1510-218-CL

- b. Turn knob – Center.
- c. Elevator trim control switch – ON.
- d. Control wheel – Hold to mid travel.
- e. **AP** button – Press. **AP ENGAGE** and **YD ENGAGE** annunciators on autopilot controller will flash. Servo clutches will engage. **FD** flag on ADI should be in view.
- f. Control movement – Check.
  - (1) Rudder pedals – Overpower slowly. **YD ENGAGE** annunciator stops flashing.
  - (2) Control wheel – Overpower slowly in both pitch and roll axis. **AP ENGAGE** annunciator stops flashing. **FD** flag on ADI retracts.

### WARNING

**If autopilot or yaw damper disengages during overpower test or if AP ENGAGE or YD ENGAGE annunciator continues to flash, the system is considered non-operative and should not be used. The elevator trim system must not be forced beyond the limits indicated on the elevator trim tab indicator.**

- g. Elevator trim follow-up – Check.
  - (1) Control wheel – Hold aft of mid travel. Trim wheel should run nose down after approximately 3 seconds. Trim down annunciator should illuminate after approximately 8 seconds.

## TM 1-1510-218-CL

- (2) Control wheel – Hold forward of mid travel. Trim wheel should run nose up after approximately 3 seconds, trim up annunciator should illuminate after approximately 8 seconds, and **AP TRIM FAIL** annunciator and **MASTER WARNING** lights should illuminate after approximately 15 seconds.
- h. **AP/YD & TRIM DISC** Button – Press through second level. Autopilot and yaw damper should disengage and **ELEC TRIM OFF** annunciator should illuminate. **AP ENG** and **YD ENG** annunciators on instrument panel should flash five times.
- i. Elevator trim control switch – **OFF**, then on. **ELEC TRIM OFF** annunciator should extinguish.
- j. **AP** – Re-engage and overpower another time.
- k. Turn controller – Check that control wheel follows in each applied direction, then center.
- l. Pitch wheel – Check that trim responds to pitch wheel movement. **UP TRIM** and **DN TRIM** annunciators may illuminate.
- m. Heading bug – Center and engage **HDG**. Check that control follows a turn in each direction.
- n. Disengage **AP** by selecting **GA**. Check that **AP** disengages and **FD** commands 7° nose up, wings level attitude.

## AUTOFEATHER/AUTO IGNITION

1. Condition levers – **LOW IDLE**.
2. **ENG AUTO IGN** Switches – On.



## TM 1-1510-218-CL

3. **AUTOFEATHER** switch – Hold to **TEST**.
4. **POWER** levers – Advance until **IGN ON** lights are extinguished and **AUTOFEATHER** lights are illuminated, approximately 22% torque.
5. **#1 POWER** lever – Retard and check.
  - a. At 16 – 21% torque – **#2 AUTOFEATHER** light out, **#1 IGN ON** light illuminated.
  - b. At 9 – 14% torque – Both **AUTOFEATHER** lights out (propeller starts to feather).
6. **#1 POWER** lever – Approximately 22% torque.
7. Repeat steps 1 through 6 for **#2** engine.
8. **POWER** levers – **IDLE** (both **AUTOFEATHER** lights out, neither propeller feathers and both **IGN ON** lights illuminated).
9. **AUTOFEATHER** switch – **ARMED**.
10. **ENG AUTO IGN** switches – **OFF**.

## OVERSPEED GOVERNORS

1. **RUDDER BOOST** switch – On.
2. **PROP** levers – **HIGH RPM**.
3. **PROP GOV TEST** switch – Hold in **TEST** position.
4. Left **POWER** lever – Increase until propeller is stabilized at 1830 – 1910 RPM. Continue to increase until rudder movement is noted. (Observe **ITT** and torque limits.)
5. **POWER** lever – Retard to **IDLE**.
6. Repeat steps 3, 4, and 5 for the right engine.

## PRIMARY GOVERNORS

1. **POWER** – Set 1800 RPM.

### NOTE

Reduce **PROP** levers gently to the detent to prevent the **PROP** RPM dropping abruptly below 1600 RPM.

2. **PROP** levers aft gently to detent – Set.
3. Propeller RPM 1600 to 1640 – Check.
4. **PROP** levers – **HIGH RPM**.

## ICE VANES

1. **ICE VANE** switches – **EXTEND**. Verify torque drop, TGT increase, illumination of **VANE EXT** light and visually confirm the bypass doors are open. Maximum allowable time for the complete operation is 15 seconds – Check.
2. **ICE VANE** switches – **RETRACT**. Verify return to original torque and TGT, **VANE EXT** light extinguished, and visually confirm the bypass doors are closed. Maximum allowable time for the complete operation is 15 seconds – Check.

## ANTI-ICE AND DEICE SYSTEMS

1. **WSHLD ANTI-ICE** switches – **NORMAL**. Check **PILOT** and **COPILOT** (individually) for loadmeter rise, then **OFF**.
2. **PROP** deice switches – Check when **MANUAL** is selected. Note rise on DC loadmeter. When **AUTO** mode is selected, monitor prop ammeter for 2 minutes and ensure the indicator remains in the normal operating range for entire time.

## TM 1-1510-218-CL

3. **DEICE** switch – **SINGLE CYCLE AUTO**. Check for a drop in pneumatic pressure and wing-deice boots inflation and after 6 seconds for a second drop in pneumatic pressure.

### PNEUMATIC SYSTEM

1. **LEFT BLEED AIR VALVE** switch – **OFF**.
2. Pneumatic pressure 12 to 20 psi – Check.
3. **L BL AIR OFF** light on – Check.
4. **RIGHT BLEED AIR VALVE** switch – **OFF**.
5. **L & R BL AIR OFF**, **L & R BL AIR FAIL** lights and **MASTER WARNING** light – **ON**.
6. **LEFT BLEED AIR VALVE** switch – **OPEN**.
7. **L BL AIR OFF** and **L & R BL AIR FAIL** lights – **OFF** and pneumatic pressure at 12 to 20 psi - Check.
8. **RIGHT BLEED AIR VALVE** switch – **OPEN**.
9. **R BL AIR OFF** light off – Check.

### PRESSURIZATION SYSTEM

1. **CABIN DOOR** caution light extinguished – Check.
2. Vent windows closed – Check.
3. **BLEED AIR VALVE** switches – **OPEN**.
4. Cabin altitude 500 feet lower than field pressure altitude – Set.
5. **CABIN PRESS** switch – **TEST** (hold).
6. **CABIN CLIMB** gauge descending indication – Check, then release **TEST** switch.

## **TM 1-1510-218-CL**

7. **ACFT ALT** – Set to pressure altitude plus 200 feet.
8. **RATE** control – Set between 9 and 12 o'clock.

### **DEPARTURE BRIEFING**

1. ATC clearance – Review.
  - a. Routing.
  - b. Initial altitude.
2. Departure procedure – Review.
  - a. Named departure procedure.
  - b. Obstacle clearance departure procedure / noise abatement procedure.
  - c. Visual flight rules departure route.
3. Copilot duties – Review.
  - a. Adjust takeoff power.
  - b. Monitor engine instruments.
  - c. Power check at 65 knots.
  - d. Call out engine malfunctions.
  - e. Tune/identify all nav/comm radios.
  - f. Make all radio calls.
  - g. Adjust transponder and radar as required.
  - h. Complete flight log during flight and note altitudes and headings.
  - i. Note departure time.
4. TOLD card – Review.

## TM 1-1510-218-CL

- a. Takeoff power.
- b.  $V_1/V_r$ .
- c.  $V_2+10$  (climb to 1500 feet AGL).
- d.  $V_2/V_{yse}$ .

## ARRIVAL BRIEFING

1. Weather/altimeter setting.
2. Airfield/facilities – Review.
  - a. Field elevation.
  - b. Runway length.
  - c. Runway condition.
3. Approach procedure – Review.
  - a. Approach plan/profile.
  - b. Altitude restrictions/VDP.
  - c. Missed approach.
    - (1) Point.
    - (2) Time.
    - (3) Intentions.
  - d. Decision height or minimum descent altitude.
  - e. Lost communications.
4. Backup approach/frequencies.
5. Copilot's duties – Review.
  - a. Nav/comm set-up.
  - b. Monitor altitude and airspeeds.

**TM 1-1510-218-CL**

- c. Monitor approach.
  - d. Call out visual/field in sight.
6. Landing performance data – Review.
- a. Approach speed.
  - b. Runway required.
7. Passenger briefing – As required.

**TM 1-1510-218-CL**

**OPERATOR'S AND  
CREWMEMBER'S CHECKLIST**

**PART II**

**ARMY C-12T AIRCRAFT**  
**NSN 1501-01-470-0220**

## NORMAL PROCEDURES

### BEFORE EXTERIOR CHECK

- \*1. Forms/publications – Check.
- \*2. Oxygen system – Check.
- \*3. Flight controls – Unlocked and checked.
- \*4. Parking brake – As required.
- 5. Manual trim – Check and set to zero.
- \*6. **LDG GEAR CONTR – DN.**
- \*7. **EFIS POWER – OFF.**
- ★ 8. Fuel pumps/crossfeed operation – Check.
- \*9. Fuel gauges – Check quantity.
- ★\* 10. **EFIS POWER and INVERTERS – ON, check, OFF.**
- 11. Subpanel – Check and set.
- 12. Lighting and Heating Systems – Check.
- 13. **BATT switch – OFF.**
- 14. Galley power switches – Off.
- 15. Toilet – Check.
- 16. Emergency equipment – Check.

### FUEL SAMPLE AND OIL CHECK

- 1. Fuel sample – Check.

### LEFT WING, AREA 1

- 1. Left wing – Check.
- 2. Left main landing gear – Check.
- 3. Left engine and propeller – Check.



## **TM 1-1510-218-CL**

4. Left wing center section – Check.
5. Fuselage underside – Check.

### **NOSE SECTION, AREA 2**

1. Nose section – Check.

### **RIGHT WING, AREA 3**

1. Right wing center section – Check.
2. Right engine and propeller – Check.
3. Right main landing gear – Check.
4. Right wing – Check.

### **FUSELAGE RIGHT SIDE, AREA 4**

1. Fuselage right side – Check.

### **EMPENNAGE, AREA 5**

1. Empennage – Check.

### **FUSELAGE LEFT SIDE, AREA 6**

1. Fuselage left side – Check.
- \*2. Chocks and tiedowns – Removed.

### **INTERIOR CHECK**

1. Cargo/loose equipment – Check secure.
- ★ 2. Cabin door – Locked and checked.
3. Cargo door – Locked and checked.
4. Emergency exit – Check.
- ★ 5. Crew/passenger briefing – Complete.

## TM 1-1510-218-CL

### BEFORE STARTING ENGINES

- \*1. Parking brake – Set.
- \*2. Oxygen system – Set.
3. Circuit breakers – Check.
- \*4. Overhead panel – Check.
- \*5. Fuel panel switches – Check.
6. Magnetic compass – Check.
7. **CLOCK** and **MAP** lights – **OFF**.
- \*8. Pedestal controls – Set.
9. Lower console switches – Set.
10. Gear ratchet handle – Stowed.
11. Free air temperature gauge – Check.
12. Pilot's instrument panel – Check and set.
13. Copilot's instrument panel – Check and set.

### FIRST ENGINE START (BATTERY START)

1. **BATT** switch – **ON**.
2. **EXTERIOR LIGHTS** – As required.
3. Propeller – Clear.
4. Engine – Start.
5. Engine and systems instruments – Check.
6. **CONDITION** lever – **HIGH IDLE**.
7. **GEN** switch – **RESET**, then **ON**.

## **SECOND ENGINE START (BATTERY START)**

1. First engine generator load 50% or less – **GEN** switch **OFF**.
2. Propeller area – Clear.
3. Engine – Start.
4. Engine and systems instruments – Check.
5. **BATTERY CHARGE** light on – Check.
6. **INVERTER** switches – **ON**, check, **INVERTER** lights **OFF**.
7. Second engine **GEN** switch – **RESET**, then **ON**.
8. **CONDITION** levers – As required.
9. Red anticollision light – Reset.

## **ABORT START**

1. **CONDITION** lever – **FUEL CUTOFF**.
2. **IGNITION AND ENGINE STARTER** switch – **STARTER ONLY**.
3. ITT/TGT – Monitor for drop in temperature.
4. **IGNITION AND ENGINE START** switch – **OFF**.

## **ENGINE CLEARING**

1. **CONDITION** lever – **FUEL CUTOFF**.
2. **IGNITION AND ENGINE START** switch – **OFF** (1-minute minimum).
3. **IGNITION AND ENGINE START** switch – **STARTER ONLY** (15 seconds minimum,

## TM 1-1510-218-CL

40 seconds maximum).

4. **IGNITION AND ENGINE START** switch – **OFF**.

### \***FIRST ENGINE START (GPU START)**

1. **BATT** switch – **OFF**.
2. GPU – Connect.
3. **EXTERNAL POWER** advisory light – On.
4. **BATT** switch – **ON**.
5. **EXTERIOR LIGHTS** switches – As required.
6. Propeller – Clear.
7. Engine – Start.
8. Engine and systems instruments – Check.
9. **CONDITION** lever – **HIGH IDLE**.
10. GPU disconnect – As required.
11. **GEN** switch – **RESET** then **ON**.
12. **BATTERY CHARGE** light – Monitor.

### \***SECOND ENGINE START (GPU START)**

1. Propeller area – Clear.
2. Engine – Start.
3. Engine and systems instruments – Check.
4. Right **PROP** lever – **FEATHER**.
5. GPU – Disconnect.
6. Right **PROP** lever – **HIGH RPM**.
7. **INVERTER** switches – **ON**, check **INVERTER**

## TM 1-1510-218-CL

lights **OFF**.

8. **GEN** switches – **RESET**, then **ON**.
9. **CONDITION** levers – As required.
10. Red anticollision light – Reset.

### BEFORE TAXIING

- \*1. AC/DC power – Check.
- \*2. **AVIONICS MASTER POWER** – **ON**.
- \*3. **EFIS POWER** – **ON**.
- \*4. **CABIN AIR/TEMP MODE** and **CABIN AIR/TEMP** switches – Set as desired.
- \*5. **BLEED AIR VALVES** – As required.
- \*6. **BRAKE DEICE** switch – As required.
- 7. Avionics – Check and set as required.
- \*8. **TCAS** – **TEST** and set.
- 9. **FLAPS** – Check.
- \*10. Altimeters – Set and Check.

### \*TAXIING

1. Brakes – Check.
2. Flight instruments – Check.

### ENGINE RUNUP

1. Parking brake – As required.
2. Propeller feathering – Check.
- ★ 3. **AUTOFEATHER/AUTO IGN** switch – Check as required.

## TM 1-1510-218-CL

- ★ 4. Overspeed governors and rudder boost – Check as required.
- ★ 5. Primary governors – Check as required.
- ★ 6. Engine ice vanes – Check.
- 7. **CONDITION** levers – **HIGH IDLE**.
- 8. **POWER** levers – **IDLE**.
- ★ 9. Anti-ice/deice systems – Check.
- ★ 10. Vacuum and pneumatic system – Check.
- ★ 11. Automatic flight control system – Check as required.
- 12. Electric elevator trim – Check.
- ★\* 13. Pressurization – Check and set.
- 14. **CONDITION** levers – As required.
- 15. Ground Proximity Altitude Advisory System (GPAAS) – Check.

### \*BEFORE TAKEOFF

- 1. **AUTOFEATHER** switch – **ARM**.
- 2. **BLEED AIR VALVES** – As required.
- 3. **FUEL** panel – Check fuel quantity and switches positions.
- 4. Flight and engine instruments – Check.
- 5. **CABIN ALT** – Set PA + 200 feet.
- 6. Annunciator panels – Check.
- 7. **PROP** levers – **HIGH RPM**.
- 8. **FLAPS** – As required.
- 9. Trim – Set.

## TM 1-1510-218-CL

10. Avionics – Set.
11. Flight Controls – Check.
- ★ 12. Departure briefing – Complete.
13. **CABIN SIGNS** switch – As required.

### \*LINE UP

1. **ICE & RAIN** switches – As required.
2. Altitude alerter – Check.
3. Transponder/TCAS/Wx radar – As required.
4. **ENG AUTO IGN – ARM.**
5. Lights – As required.
6. **CONDITION** levers – **HIGH IDLE.**
7. **POWER** – Stabilized 27% minimum.

### AFTER TAKEOFF

1. **GEAR – UP.**
2. **FLAPS** (105 KIAS) – **UP.**
3. **LANDING/TAXI** lights – **OFF.**
4. Climb power – Set.

### CLIMB

1. **YAW DAMP** – As required.
2. Cabin pressurization – Check.
3. **AUTOFEATHER** switch – As required.
4. **BRAKE DEICE** switch – As required.

## TM 1-1510-218-CL

5. **WSHLD ANTI-ICE** – As required.
6. Wings and nacelles – Check.
7. **TCAS** – Set range.

## CRUISE

1. **POWER** – Set.
2. **ICE & RAIN** switches – As required.
3. **CABIN SIGNS** switch – As required.
4. Auxiliary fuel gauges – Monitor.
5. Altimeters – Check.
6. Engine instruments– Check.
7. **RECOG** lights – As required.
8. **TCAS** – Set for en route.

## DESCENT - ARRIVAL

1. Cabin pressurization – Set.
2. **CABIN SIGNS** switch – As required.
3. **ICE & RAIN** switches – As required.
4. **WSHLD ANTI-ICE** – As required.
5. **RECOG** lights – **ON**.
6. Radar altimeter – As required.
7. Altimeters – Set to current altimeter setting.
8. **TCAS** – Set as required.
- ★ 9. Arrival briefing – Complete.



## DESCENT – MAXIMUM RATE (CLEAN)

1. Cabin pressurization – Set.
2. **CABIN SIGNS** switch – As required.
3. **POWER** levers – **IDLE**.
4. **PROP** levers – **HIGH RPM**.
5. **GEAR** – **UP**.
6. **FLAPS** – **UP**.
7. Airspeed –  $V_{mo}$  maximum.
8. **ICE & RAIN** switches – As required.
9. **RECOG** lights – As required.

## DESCENT – MAXIMUM RATE (LANDING CONFIGURATION)

1. Cabin pressurization – Set.
2. **CABIN SIGNS** switch – As required.
3. **POWER** levers – **IDLE**.
4. **PROP** levers – **HIGH RPM**.
5. **FLAPS** – **APPROACH**.
6. **GEAR** – **DN**.
7. Airspeed – 181 KIAS maximum.
8. **ICE & RAIN** switches – As required.
9. **RECOG** lights – As required.

## TM 1-1510-218-CL

### APPROACH

1. **EHSI NAV SOURCE** – As required.
2. **TCAS** – Set as required.

### BEFORE LANDING

1. **CABIN SIGNS** switch – **BOTH**.
2. **AUTOFEATHER** switch – **ARM**.
3. **BRAKE DEICE** switch – As required.
4. **PROP** levers – As required.
5. **FLAPS** (below 199 KIAS) – **APPROACH**.
6. **GEAR** (below 181 KIAS) – **DN**, confirm.
7. **LANDING LIGHTS** – As required.
8. **CONDITION** levers – **HIGH IDLE**.
9. **TCAS** – Set as required.

### LANDING

1. **AP & YD** – Disengaged.
2. **GEAR DOWN** lights – Check/confirm.
3. **PROP** levers – **HIGH RPM**.

### TOUCH AND GO LANDING

1. **PROP** levers – **HIGH RPM**.
2. **FLAPS** – As required.
3. Trim – Set.
4. Power stabilized – Check 27% minimum.

## TM 1-1510-218-CL

5. Takeoff power – Set.

### GO AROUND/MISSED APPROACH

1. Power – As required.
2. **GEAR – UP.**
3. **FLAPS – APPROACH.**
4. **FLAPS (105 KIAS) – UP.**
5. **LANDING/TAXI LIGHTS – OFF.**
6. Climb power – Set.
7. **YAW DAMP** – As required.
8. **BRAKE DEICE** switch – Off.

### AFTER LANDING

1. **CONDITION** levers – As required.
2. **AUTO IGN** – Off.
3. **ICE & RAIN** switches – Off.
4. **FLAPS – UP.**
5. **XPNDR** – As required.
6. Radar – As required.
7. Lights – As required.

### ENGINE SHUTDOWN

1. **BRAKE DEICE** switch – Off.
2. Parking brake – Set.
3. **LANDING/TAXI** lights – **OFF.**

## TM 1-1510-218-CL

4. **EFIS POWER – OFF.**
5. **INVERTERS – OFF.**
6. **AUTOFEATHER** switch – **OFF.**
7. **CABIN AIR/TEMP MODE** switch – **OFF.**
8. **VENT** and **AFT VENT BLOWER** switch – **AUTO.**
9. **BATT** condition – Check.
10. **ITT/TGT** – Check.
11. **CONDITION** levers – **FUEL CUTOFF.**
12. **PROP** levers – **FEATHER.**
13. **AVIONICS MASTER POWER – OFF.**
14. **MASTER PANEL LIGHTS** – Off.
15. **EXTERIOR LIGHTS – OFF.**
16. **MASTER SWITCH** – Off.
17. Key lock switch – **OFF.**
18. Oxygen system – **OFF.**
19. Chocks – As required.
20. Parking brake – As required.
21. Control locks – As required.

## **BEFORE LEAVING AIRCRAFT**

1. Wheel chocks – As required.
2. Parking brake – As required.
3. Flight controls – As required.
4. **OVERHEAD FLOOD LIGHT – OFF.**

**TM 1-1510-218-CL**

5. **STANDBY PUMPS – OFF.**
6. **MAP** lights – **OFF.**
7. Windows – As required.
8. Emergency exit lock – As required.
9. Galley power switches – **OFF.**
10. Aft cabin light – **OFF.**
11. Door light – **OFF.**
12. Walk-around inspection – Complete.
13. Aircraft forms – Complete.
14. Aircraft secured – Check.

## EMERGENCY PROCEDURES

### ENGINE MALFUNCTION

#### ENGINE MALFUNCTION BEFORE $V_1$ (ABORT)

1. POWER levers – **IDLE**.
2. Braking – As required.

#### ENGINE MALFUNCTION AFTER $V_1$

1. GEAR (positive climb) – **UP**.
2. POWER – As required.
3. FLAPS (105 KIAS) – **UP**.

IF THE PROP DID NOT FEATHER, PERFORM STEP 4.

4. PROP (dead engine) – **FEATHER**.

ONCE THE PROP IS FEATHERED, PERFORM STEPS 5 THROUGH 8.

- 5. TCAS – Set **TA**.
6. **LANDING/TAXI LIGHTS** – **OFF**.
7. **BRAKE DEICE** – **OFF**.
8. Engine cleanup – Perform.

#### ENGINE MALFUNCTION DURING FLIGHT

1. Autopilot/yaw damp – Disengage.
2. POWER – As required.
3. Dead engine – Identify.
4. PROP lever (dead engine) – **FEATHER**.

**TM 1-1510-218-CL**

5. GEAR – As required.
6. FLAPS – As required.
- O 7. TCAS – Set **TA**.
8. Power – Set for single-engine cruise.
9. Engine cleanup – Perform.

**ENGINE MALFUNCTION DURING FINAL APPROACH**

1. POWER – As required.
2. GEAR – DN.

**ENGINE MALFUNCTION (SECOND ENGINE)**

1. Airspeed – As required.
2. PROP lever – As required.

**ENGINE SHUTDOWN IN FLIGHT**

1. **POWER** lever – **IDLE**.
2. **PROP** lever – **FEATHER**.
3. **CONDITION** lever – **FUEL CUTOFF**.
4. Engine cleanup – Perform.

**ENGINE CLEANUP**

1. **CONDITION** lever – **FUEL CUTOFF**.
2. **ENG AUTO IGN** – **OFF**.
3. **AUTOFEATHER** switch – **OFF**.
4. **GEN** switch – **OFF**.
5. **PROP SYNC** switch – **OFF**.

## ENGINE RESTART DURING FLIGHT (USING STARTER)

1. **CABIN AIR/TEMP MODE** switch – **OFF**.
2. Electrical load – Reduce to minimum.
3. **FIRE PULL** handle – In.
4. **POWER** lever – **IDLE**.
5. **PROP** lever – **FEATHER**.
6. **CONDITION** lever – **FUEL CUTOFF**.
7. **TGT** (operating engine) – 700 °C or less.
8. Engine – Start.
9. **GEN** switch – **RESET**, then **ON**.
10. Engine cleanup – Perform if engine restart is unsuccessful.
11. **CABIN AIR/TEMP MODE** switch – As required.
12. Electrical equipment – As required.
13. **ENG AUTO IGN** switch – **ARM**.
14. **PROP SYNC** switch – As required.
15. **POWER** – As required.

## ENGINE RESTART DURING FLIGHT (NOT USING STARTER)

1. **CABIN AIR/TEMP MODE** switch – **OFF**.
2. Electrical load – Reduce to minimum.
3. **GEN** switch (affected engine) – **OFF**.
4. **FIRE PULL** handle – In.
5. **POWER** lever – **IDLE**.



## TM 1-1510-218-CL

6. **PROP** lever – **HIGH RPM**.
7. **CONDITION** lever – **FUEL CUTOFF**.
8. Airspeed – 140 KIAS minimum.
9. Altitude – Below 20,000 feet.
10. **ENG AUTO IGN** switch – **ARM**.
11. **CONDITION** lever – **LOW IDLE**.
12. **TGT** – 1000° 5 seconds maximum.
13. Oil pressure – Check.
14. **GEN** switch – **RESET**, then **ON**.
15. Engine cleanup – Perform if engine restart is unsuccessful.
16. **CABIN AIR/TEMP MODE** switch – As required.
17. Electrical equipment – As required.
18. Propellers – Synchronized.
19. **POWER** – As required.

## LOW OIL PRESSURE

1. Torque – 49% maximum. Oil pressure less than 105 psi below 21,000 feet or 85 psi 21,000 feet and above.
2. Oil pressure below 60 psi. Perform engine shutdown or land as soon as practicable using minimum power to ensure safe arrival.

## CHIP DETECTOR WARNING LIGHT ILLUMINATED

If a **CHIP DET** warning light illuminates and safe single-engine flight can be maintained, perform engine shutdown.

**DUCT OVERTEMP CAUTION LIGHT  
ILLUMINATED**

1. **CABIN AIR** control – In.
2. **CABIN AIR/TEMP MODE** switch – **AUTO**.
3. **CABIN AIR/TEMP** switch – Decrease.
4. **VENT BLOWER** switch – **HI**.
5. **CABIN AIR/TEMP MODE** switch – **MAN COOL**.
6. **MANUAL TEMP** switch – **DECREASE** (hold).
7. **LEFT BLEED AIR VALVE** switch – **PNEU & ENVIRO OFF**.
8. Light still illuminated (30 seconds) **LEFT BLEED AIR VALVE** switch – **OPEN**.
9. **RIGHT BLEED AIR VALVE** switch – **PNEU & ENVIRO OFF**.
10. Light still illuminated (30 seconds) **RIGHT BLEED AIR VALVE** switch – **OPEN**.

**ICE VANE FAILURE**

1. Airspeed – 160 KIAS or below.
2. **ICE VANE CONTR** circuit breaker – Pull.
3. **ICE VANE** – Operate manually.
4. Airspeed – Resume normal airspeed.

**ENGINE BLEED AIR SYSTEM  
MALFUNCTION**

**BLEED AIR FAILURE LIGHT ILLUMINATED**

1. **BRAKE DEICE** switch – Off.

**TM 1-1510-218-CL**

2. **TGT** and **TORQUE** – Monitor (note readings).
3. **BLEED AIR VALVE** switch – **OFF**.
4. Cabin pressurization – Check.

**EXCESSIVE DIFFERENTIAL PRESSURE**

1. Cabin pressurization controller – Select higher setting.

IF CONDITION PERSISTS:

2. Oxygen (crew and passengers) – As required.
3. **LEFT BLEED AIR VALVE** switch – **ENVIRO OFF** (light illuminated).

IF CONDITION STILL PERSISTS:

4. **RIGHT BLEED AIR VALVE** switch – **ENVIRO OFF** (light illuminated).
5. Descend – As required.

IF CONDITION STILL PERSISTS:

6. Oxygen masks – **100%** and on.
7. **CABIN PRESS** switch – **DUMP**.
8. **BLEED AIR VALVE** switches – **OPEN** (if cabin heating is required).

**LOSS OF PRESSURIZATION (ABOVE 10,000 FEET)**

1. Crew oxygen masks – 100% and on.
2. Passenger oxygen – **ON** and checked to ensure all passengers have oxygen masks on and are receiving supplemental oxygen if required.

**CABIN DOOR CAUTION LIGHT  
ILLUMINATED**

1. **CABIN SIGNS** switch – **BOTH**.
2. **BLEED AIR VALVE** switches – **ENVIRO OFF**.
3. Descend below 14,000 feet as soon as practicable.
4. Oxygen – As required.

**SINGLE-ENGINE DESCENT/ARRIVAL**

1. **CABIN CONTROLLER** – Set.
2. **CABIN SIGNS** switch – As required.
3. **ICE & RAIN** switches – As required.
4. Altimeters – Set.
5. **RECOG/BEACON/NAV** lights – **ON**.
- ★ 6. Arrival briefing – Complete.

**SINGLE-ENGINE BEFORE LANDING**

1. **CABIN SIGNS** switch – **BOTH**.
2. **BRAKE DEICE** – Off.
3. **PROP** lever – As required.
4. **FLAPS** (Below 199 KIAS) – **APPROACH**.
5. **GEAR** (Below 181 KIAS) – **DN**.
6. **LANDING/TAXI LIGHTS** – As required.
7. **CONDITION** lever (operating engine) – **HIGH IDLE**.

## **SINGLE-ENGINE LANDING CHECK**

1. **AP/YD** – Disengaged.
2. **GEAR DOWN** lights – Check.
3. **PROP** lever (live engine) – **HIGH RPM**.

## **SINGLE-ENGINE GO-AROUND**

1. **POWER** – As required.
2. **GEAR – UP**.
3. **FLAPS – APPROACH**.
4. **FLAPS (105 KIAS) – UP**.
5. **LANDING/TAXI LIGHTS – OFF**.
6. Climb power – Set.
7. **YD** – As required.

## **PROPELLER FAILURE (OVER 2120 RPM)**

1. **POWER** lever (affected engine) – **IDLE**.
2. **PROP** lever – **FEATHER**.
3. **CONDITION** lever – As required.
4. Engine cleanup – As required.

## **FIRE**

### **ENGINE FIRE**

### **ENGINE/NACELLE FIRE DURING START OR GROUND OPERATIONS**

1. **PROP** levers – **FEATHER**.

**TM 1-1510-218-CL**

2. **CONDITION** levers – **FUEL CUTOFF**.
3. **FIRE PULL** handle – Pull.
4. **PUSH TO EXTINGUISH** switch – Push.
5. **MASTER SWITCH – OFF**.

**ENGINE FIRE IN FLIGHT (IDENTIFIED)**

1. **POWER** lever – **IDLE**.
2. **PROP** lever – **FEATHER**.
3. **CONDITION** lever – **FUEL CUTOFF**.
4. **FIRE PULL** handle – Pull.
5. **Fire extinguisher** – Actuate as required.
6. Engine cleanup – Perform.

**FUSELAGE FIRE**

1. Fight the fire.
2. Land as soon as possible if fire continues.

**WING FIRE**

1. Perform engine shutdown on affected side.
2. Land as soon as possible if fire continues.

**ELECTRICAL FIRE**

1. **Crew oxygen masks** – As required.
2. Passenger oxygen – As required.
3. **MASTER SWITCH – OFF**. (Visual conditions only).

4. All nonessential electrical equipment – **OFF**.
5. **BATT** switch – **ON**.
6. Generator switches (individually) – **RESET**, then **ON**.
7. Circuit breakers – Check for indication of defective circuit.
8. Essential electrical equipment – **ON** (individually until fire source is isolated).
9. Land as soon as practicable.

## **SMOKE AND FUME ELIMINATION**

1. Crew oxygen masks – 100% and on.
2. Passenger oxygen – **ON**.
3. **BLEED AIR VALVE** switches – **ENVIRO OFF**.
4. **VENT BLOWER** switch – **AUTO**.
5. **AFT VENT BLOWER** switch – **OFF**.
6. **CABIN AIR/TEMP MODE** switch – **OFF**.
7. If smoke and fumes are not eliminated, **CABIN PRESS** switch – **DUMP**.
8. Passenger oxygen masks – Check. Confirm that all passengers are receiving supplemental oxygen.
9. Engine oil pressure – Monitor.

## **FUEL SYSTEM**

**FUEL PRESS WARNING LIGHT  
ILLUMINATED**

1. **STANDBY PUMP** switch – **ON**.

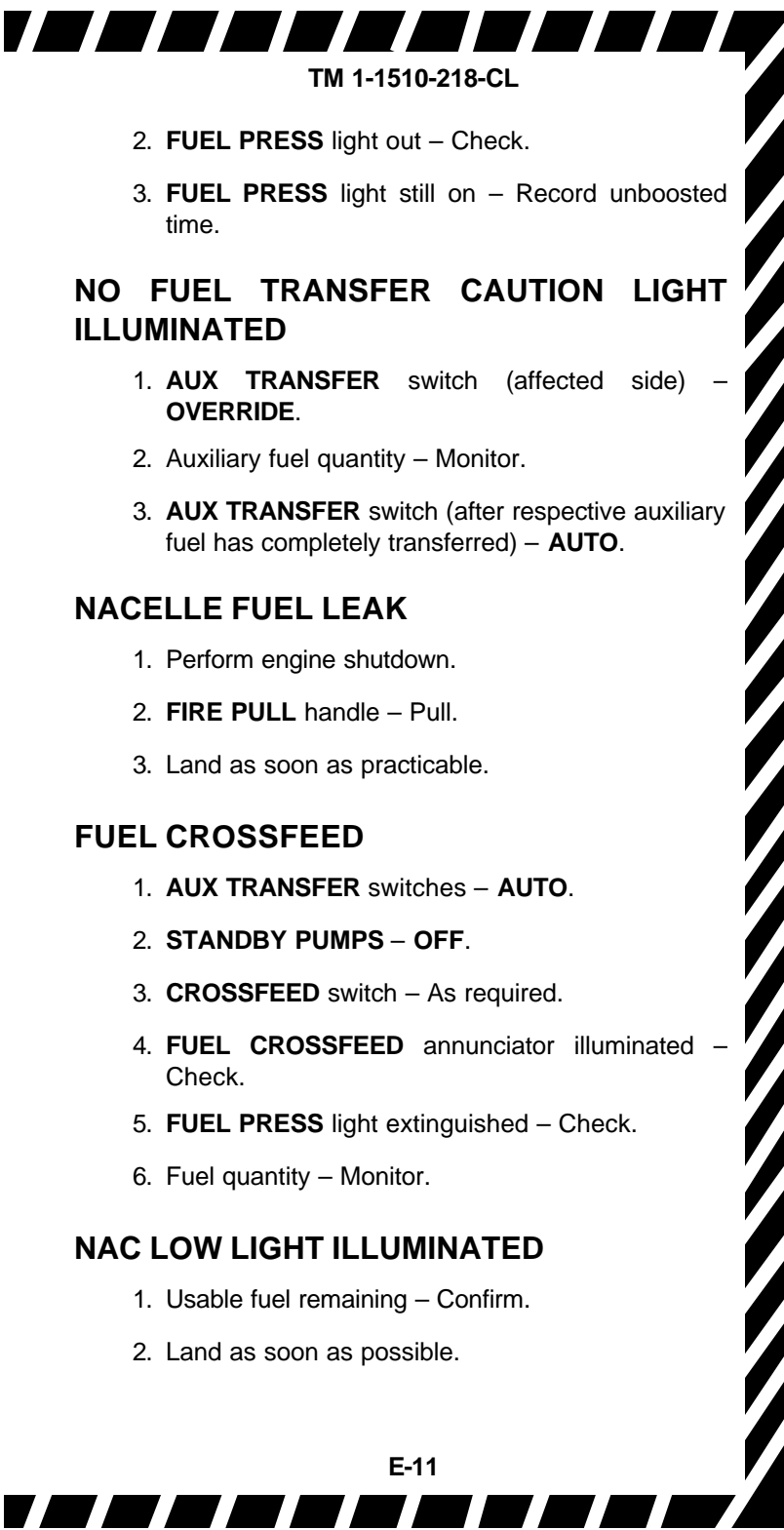

**TM 1-1510-218-CL**

2. **FUEL PRESS** light out – Check.
3. **FUEL PRESS** light still on – Record unboosted time.

**NO FUEL TRANSFER CAUTION LIGHT ILLUMINATED**

1. **AUX TRANSFER** switch (affected side) – **OVERRIDE**.
2. Auxiliary fuel quantity – Monitor.
3. **AUX TRANSFER** switch (after respective auxiliary fuel has completely transferred) – **AUTO**.

**NACELLE FUEL LEAK**

1. Perform engine shutdown.
2. **FIRE PULL** handle – Pull.
3. Land as soon as practicable.

**FUEL CROSSFEED**

1. **AUX TRANSFER** switches – **AUTO**.
2. **STANDBY PUMPS** – **OFF**.
3. **CROSSFEED** switch – As required.
4. **FUEL CROSSFEED** annunciator illuminated – Check.
5. **FUEL PRESS** light extinguished – Check.
6. Fuel quantity – Monitor.

**NAC LOW LIGHT ILLUMINATED**

1. Usable fuel remaining – Confirm.
2. Land as soon as possible.



## **ELECTRICAL SYSTEM EMERGENCIES**

### **DC GEN LIGHT ILLUMINATED**

1. **GEN** switch – **OFF**, **RESET**, then **ON**.

IF THE GENERATOR DOES NOT RESET:

2. **GEN** switch (no reset) – **OFF**.
3. Operating loadmeter – 100% maximum.

### **BOTH DC GEN LIGHTS ILLUMINATED**

1. All nonessential equipment – Off.
2. Land as soon as practicable.

### **EXCESSIVE LOADMETER INDICATION (OVER 100%)**

1. Loadmeter – Monitor.
2. **BATT** switch – **OFF** (monitor loadmeter).

IF LOADMETER STILL INDICATES ABOVE 100%:

3. Nonessential electrical equipment – off.

IF LOADMETER INDICATES 100% OR BELOW:

4. **BATT** switch – **ON**.

### **INVERTER LIGHT ILLUMINATED**

1. Affected **INVERTER** switch – **OFF**.

### **INST AC LIGHT ILLUMINATED**

1.  $N_1$  and TGT indications – Check.
2. Other engine instruments – Monitor.

## **CIRCUIT BREAKER TRIPPED**

1. **BUS FEEDER** breaker tripped – Do not reset.
2. Nonessential circuit – Do not reset.
3. Essential circuit – Reset once.

## **BATTERY CHARGE LIGHT ILLUMINATED**

1. Loadmeter – Check and note indication.
2. **BATT** switch – **OFF**.
3. Loadmeter – Check. If loadmeter indicates less than 2.5% change (one needle width), turn **BATT** switch **ON** and monitor for increasing load. If load continues to increase, turn **BATT** switch **OFF**.
4. **BATT** switch (landing gear/flap extension only) - **ON**.

## **AVIONICS MASTER POWER SWITCH FAILURE**

1. **AVIONICS MASTER CONTR** circuit breaker – Pull.

## **EMERGENCY DESCENT**

1. **POWER** levers – **IDLE**.
2. **PROP** levers – **HIGH RPM**.
3. **FLAPS** – **APPROACH**.
4. **GEAR** – **DN**.
5. Airspeed – 181 KIAS maximum.

## LANDING EMERGENCIES

### LANDING GEAR UNSAFE INDICATION

1. **LDG GEAR CONTROL** switch – Check **DN**.
2. **LANDING GEAR CONTROL** and **LANDING GEAR IND** circuit breakers – Check in.
3. **GEAR DOWN** lights illuminated – Check.

IF INDICATOR REMAINS UNSAFE:

4. Landing gear emergency extension – Perform.

### LANDING GEAR EMERGENCY EXTENSION

1. Airspeed – Below 181 KIAS.
2. **LANDING GEAR CONTR** circuit breaker – Pull.
3. **LDG GEAR CONTROL** switch – **DN**.
4. Alternate extension lever – Unstow.
5. Alternate extension lever – Pump up and down until the three green **GEAR DOWN** lights illuminate or resistance is felt.
6. Alternate extension lever – As required.

### GEAR-UP LANDING (GEAR UP OR UNLOCKED)

1. Fuel load – Reduce.
2. Personnel emergency briefing – Completed.
3. Loose equipment – Stowed.
4. **BLEED AIR VALVES** – **ENVIRO OFF**.
5. **CABIN PRESS** switch – **DUMP**.

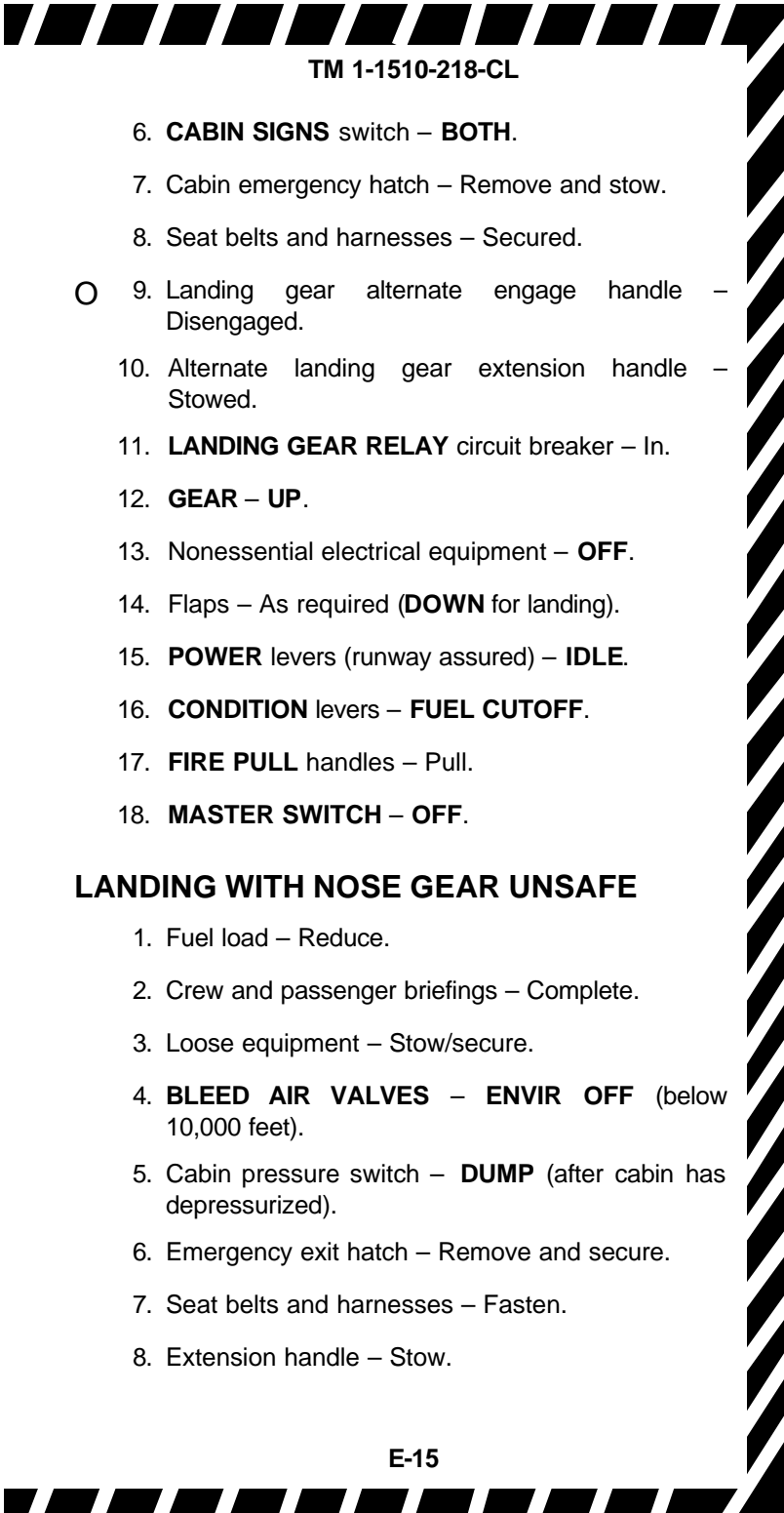

**TM 1-1510-218-CL**

6. **CABIN SIGNS** switch – **BOTH**.
7. Cabin emergency hatch – Remove and stow.
8. Seat belts and harnesses – Secured.
- 9. Landing gear alternate engage handle – Disengaged.
10. Alternate landing gear extension handle – Stowed.
11. **LANDING GEAR RELAY** circuit breaker – In.
12. **GEAR – UP**.
13. Nonessential electrical equipment – **OFF**.
14. Flaps – As required (**DOWN** for landing).
15. **POWER** levers (runway assured) – **IDLE**.
16. **CONDITION** levers – **FUEL CUTOFF**.
17. **FIRE PULL** handles – Pull.
18. **MASTER SWITCH – OFF**.

**LANDING WITH NOSE GEAR UNSAFE**

1. Fuel load – Reduce.
2. Crew and passenger briefings – Complete.
3. Loose equipment – Stow/secure.
4. **BLEED AIR VALVES – ENVIR OFF** (below 10,000 feet).
5. Cabin pressure switch – **DUMP** (after cabin has depressurized).
6. Emergency exit hatch – Remove and secure.
7. Seat belts and harnesses – Fasten.
8. Extension handle – Stow.

**TM 1-1510-218-CL**

9. **LANDING GEAR CONTROL – DN.**
10. **LANDING GEAR RELAY** circuit breaker – Pull.
11. **LANDING GEAR WARN** horn circuit breaker – Pull.
12. Before landing checklist – Complete.

**AFTER TOUCHDOWN:**

13. **POWER** levers – **IDLE.**
14. **PROP** levers – **FEATHER.**
15. **CONDITION** levers – **FUEL CUTOFF.**

**AFTER STOPPING:**

16. Fuel **FIREWALL SHUTOFF VALVES – CLOSED.**
17. **MASTER SWITCH – OFF.**

**LANDING WITH ONE MAIN GEAR UNSAFE**

1. Retract the gear and make a gear up landing.

**IF THE GEAR WILL NOT RETRACT:**

2. Fuel load – Reduce.
3. Personnel emergency briefing – Completed.
4. Loose equipment – Stowed.
5. **BLEED AIR VALVES – ENVIRO OFF.**
6. **CABIN PRESS** switch – **DUMP.**
7. **CABIN SIGNS** switch – **BOTH.**
8. Cabin emergency hatch – Remove and stow.
9. Seat belts and harnesses – Secured.
10. Nonessential electrical equipment – **OFF.**

11. Touchdown – On safe main gear first.
12. **POWER** levers – **IDLE**.
13. **CONDITION** levers – **FUEL CUTOFF**.
14. **FIRE PULL** handle – Pull.
15. **MASTER SWITCH** – **OFF**.

## **CRACKED WINDSHIELD**

### **INTERNAL CRACK**

1. Descend – Below 25,000 feet.
2. Cabin Pressure – Reset pressure differential to 4 psi or less within 10 minutes.

### **CRACKED CABIN WINDOW**

1. Crew oxygen masks – **100%** and on, if above 10,000 feet.
2. **CABIN SIGNS** switch – **BOTH**.
3. Passenger oxygen – **ON** and checked, if above 10,000 feet.
4. Cabin pressure – Depressurize.
5. Land as soon as practicable.

### **DITCHING**

1. Radio calls/transponder – As required.
2. Personnel emergency briefing – As required.
3. **BLEED AIR VALVES** – **ENVIRO OFF/PNEU ONLY**.
4. **CABIN PRESS** switch – **DUMP**.
5. **CABIN SIGNS** switch – **BOTH**.



**TM 1-1510-218-CL**

6. Cabin emergency hatch – Remove and stow.
7. Seat belts and harnesses – Secured.
8. **GEAR – UP.**
9. **FLAPS – DN.**
10. Nonessential electrical equipment – **OFF.**
11. Approach – Normal, power on.
12. Emergency lights – As required.

**FLIGHT CONTROLS MALFUNCTION**

**UNSCHEDULED RUDDER BOOST ACTIVATION**

1. **RUDDER BOOST – OFF.**
- IF CONDITION PERSISTS:
2. **RUDDER BOOST** circuit breaker – Pull.
  3. **BLEED AIR VALVE – OFF** (Below 10,000 feet).
  4. Rudder trim – Adjust.

**UNSCHEDULED ELECTRIC ELEVATOR TRIM**

1. Control wheel disconnect switch – Depress.
2. **ELEV TRIM** switch – **OFF.**
3. **ELEC TRIM** circuit breaker – **OUT.**

## PERFORMANCE CHECKS

### FUEL PUMPS/CROSSFEED OPERATION

1. **FIRE PULL** handles – Pull.
2. **STANDBY PUMP – ON.**
3. **BATT** switch – **ON** (**#1** and **#2 FUEL PRESS** lights illuminated).
4. Fuel **FIRE PULL HANDLES – IN.**
5. **#1** and **#2 FUEL PRESS** annunciators – Extinguished.
6. **STANDBY PUMPS – Off.**
7. **#1** and **#2 FUEL PRESS** annunciators – illuminated.
8. **CROSSFEED** flow alternately left and right (**FUEL CROSSFEED** annunciator illuminated, **#1** and **#2 FUEL PRESS** annunciators extinguished).
9. **CROSSFEED** flow – **OFF.**
10. **AUX TRANSFER – AUTO.**

### EFIS POWER AND INVERTERS

1. **EFIS POWER – Push ON.**
2. Turn **ON** either **INVERTER.**
3. Ensure both pilots' EADI and EHSD are fully operational.
4. **EFIS POWER** and **INVERTERS – Off.**



## FIRE EXTINGUISHER PRESSURE

A gauge, calibrated in psi, is mounted on each supply cylinder for determining the level of charge and should be checked during preflight. Refer to Table P-1.

*Table P-1. Engine Fire Extinguisher Gauge Pressure*

TEMP °C	-40	-29	-18	-06	04	16	20	38	48
	190	220	250	290	340	390	455	525	605
PSI	to	to	to	to	to	to	to	to	to
	240	275	315	365	420	480	550	635	730

## CABIN DOOR

1. Open cabin door – Check that **CABIN DOOR** annunciator is extinguished.
2. Latch cabin door, but do not lock – Check that **CABIN DOOR** annunciator illuminates.
3. **BATT** switch – **ON**. Check that **CABIN DOOR** annunciator is still illuminated.
4. Close and lock cabin door – Check that **CABIN DOOR** annunciator is extinguished.
5. **BATT** switch – **OFF**.

## CREW/PASSENGER BRIEFING

1. Crew introduction.
2. Equipment.
  - a. Personnel to include ID tags.
  - b. Professional (medical equipment, etc.).
  - c. Survival.

## TM 1-1510-218-CL

3. Flight data.
  - a. Route.
  - b. Altitude.
  - c. Time en route.
  - d. Weather.
4. Normal Procedures.
  - a. Entry and exit of aircraft.
  - b. Seating and seat position.
  - c. Seat belts.
  - d. Movement in aircraft.
  - e. Internal communications.
  - f. Security of equipment.
  - g. Smoking.
  - h. Oxygen.
  - i. Refueling.
  - j. Weapons and prohibited items.
  - k. Protective masks.
  - l. Toilet.
5. Emergency Procedures.
  - a. Emergency exits.
  - b. Emergency equipment.
  - c. Emergency landing / ditching procedures.

## **AUTOFEATHER/AUTO IGN**

1. **AUTO IGN** switches – **ARM. IGN ON** annunciators illuminated.

## TM 1-1510-218-CL

2. **POWER** levers – 22% torque. **IGN ON** annunciators extinguish.
3. **AUTOFEATHER** switch – Hold to **TEST**. Both **AUTOFEATHER** annunciators illuminated.
4. **POWER** levers – Retard individually.
  - a. Approximately 16% – 21% torque, opposite **AUTOFEATHER** annunciator extinguishes, **IGN ON** annunciator illuminated.
  - b. Approximately 9% – 14% torque, both **AUTOFEATHER** annunciators extinguished (prop begins to feather). Both **IGN ON** annunciators illuminated.

### NOTE

**AUTOFEATHER** annunciators will illuminate and extinguish with each fluctuation of torque as the propeller attempts to feather.

- c. Return **POWER** lever to 22% torque.
5. Repeat procedure with other engine.
6. **POWER** levers – **IDLE** (Both **AUTOFEATHER** lights extinguished, props do not feather).
7. **AUTOFEATHER** switch – **ARM**.
8. **AUTO IGN** switches – Off.

## OVERSPEED GOVERNORS AND RUDDER BOOST

1. **RUDDER BOOST** switch – On.
2. **PROP** levers – **HIGH RPM**.
3. **LEFT PROP GOV TEST** switch – Hold in **TEST** position.

## TM 1-1510-218-CL

4. Left **POWER** lever – Increase until propeller is stabilized at 1830 RPM – 1910 RPM. Continue to increase until rudder movement is noted. Observe ITT/TGT and torque limits and PROP remains stabilized at 1830 RPM – 1910 RPM.
5. **POWER** lever – Retard to **IDLE**.
6. Repeat steps 3, 4, and 5 for the right engine.

## PRIMARY GOVERNORS

1. **POWER** levers – Set 1800 RPM.
2. **PROP** levers – Retard to **FEATHER** detent. Note propellers stabilize between 1600 and 1640 RPM.
3. **PROP** levers – **HIGH RPM**. Note propellers return to 1800 RPM.

## ENGINE ICE VANES

1. **ICE VANES** – On/**EXTENDED**.
  - a. Both advisory lights illuminated.
  - b. Both bypass doors extended.
  - c. Maximum time for a and b is 15 seconds.
2. **ICE VANES** – Off/**RETRACTED**.
  - a. Both advisory lights extinguish.
  - b. Both bypass doors retracted.
  - c. Maximum time for a and b is 15 seconds.

## ANTI-ICE/DEICE SYSTEMS

1. Prop deice – Check. When **MANUAL** mode is selected, note rise on DC loadmeter. When **AUTO** mode is selected, monitor prop ammeter for the appropriate number of seconds and ensure the indicator remains in the normal operating range the entire time.
2. Windshield heat – Check. Note increases on the loadmeter and cycle through both normal and high settings.

### NOTE

If windshield heat is needed prior to takeoff, use **NORMAL** setting for a minimum of 15 minutes prior to selecting **HIGH** to provide adequate preheating and minimize the effects of thermal shock. The windshield heat thermostat will invalidate the check in OAT above 20° to 30 °C.

3. All anti-ice/deice switches – **OFF**.
4. Surface deice system – Check.

## VACUUM AND PNEUMATIC SYSTEM

1. **LEFT BLEED AIR VALVE – OFF**.
  - a. Pneumatic and suction pressures remain normal.
  - b. **L BL AIR OFF** annunciator illuminates
  - c. Both **BL AIR FAIL** annunciators remain extinguished.
2. **RIGHT BLEED AIR VALVE – OFF**.
  - a. Pneumatic and suction pressures read zero.
  - b. Both **BL AIR OFF** and **BL AIR FAIL** annunciators illuminated.

## TM 1-1510-218-CL

3. **LEFT BLEED AIR VALVE – ON/OPEN.**
  - a. Pneumatic and suction pressures return to normal.
  - b. **L BL AIR FAIL** annunciator extinguished.
4. **RIGHT BLEED AIR VALVE – ON/OPEN.**
  - a. **R BL AIR OFF** annunciator extinguished.
  - b. Both **BL AIR FAIL** annunciators extinguished.

## AUTOMATIC FLIGHT CONTROL SYSTEM

1. Altitude alert.

### NOTE

**Pause a few seconds after each step to allow time for the proper indications.**

- a. Set alert controller more than 1000 feet above altitude indicated on pilot's altimeter. The pilot's altimeter alert light should be extinguished.
  - b. Decrease the alert controller to within 1000 feet of the pilot's altimeter setting. The alert light should illuminate.
  - c. Decrease the controller to less than 250 feet above the pilot's altimeter setting. The alert light should extinguish.
  - d. Increase the controller to  $300 \pm 50$  feet above the pilot's altimeter indication and check that the alert light illuminates.
  - e. Set the desired altitude.
2. Autopilot.
    - a. Autopilot controller **UP TRIM** and **DN TRIM** annunciators – Check not illuminated.

**CAUTION**

A steady illumination of UP TRIM or DN TRIM annunciator indicates that the automatic synchronization is not functioning and the autopilot should not be engaged.

- b. Turn knob – Center.
- c. **ELEV TRIM** switch – On.
- d. Control wheel – Hold to mid travel.
- e. **AP** button – Press. **AP ENGAGE** and **YD ENGAGE** annunciators on autopilot controller will flash. Servo clutches will engage. FD flag on ADI should be in view.
- f. Control movement – Check.
  - (1) Rudder pedals – Overpower slowly. **YD ENGAGE** annunciator stops flashing.
  - (2) Control wheel – Overpower slowly in both pitch and roll axis. **AP ENGAGE** annunciator stops flashing. FD flag on ADI retracts.

**WARNING**

If autopilot or yaw damper disengages during overpower test or if **AP ENGAGE** or **YD ENGAGE** annunciator continues to flash, the system is considered non-operative and should not be used. The elevator trim system must not be forced beyond the limits that are indicated on the elevator trim tab indicator.

- g. Elevator trim follow-up – Check.

## TM 1-1510-218-CL

- (1) Control wheel – Hold aft of mid travel. Trim wheel should run nose down after approximately 3 seconds. Trim down annunciator should illuminate after approximately 8 seconds.
  - (2) Control wheel – Hold forward of mid travel. Trim wheel should run nose up after approximately 3 seconds, trim up annunciator should illuminate after approximately 8 seconds, and **AP TRIM FAIL** annunciator and **MASTER WARNING** lights should illuminate after approximately 15 seconds.
- h. **AP/YD & TRIM DISC** button – Press through second level. Autopilot and yaw damper should disengage and **ELEV TRIM OFF** annunciator should illuminate. **AP ENG** and **YD ENG** annunciators on instrument panel should flash five times.
  - i. **ELEV TRIM** switch – **OFF**, then On. **ELEV TRIM OFF** annunciator should extinguish.
  - j. **AP** – Re-engage and overpower another time.
  - k. Turn controller – Check that control wheel follows in each applied direction and center.
  - l. Pitch wheel – Check that trim responds to pitch wheel movement. **UP TRIM** and **DN TRIM** annunciators may illuminate.
  - m. Heading bug – Center and engage HDG. Check that control follows a turn in each direction.
  - n. Disengage **AP** by selecting **GA**. Check that **AP** disengages and **FD** commands 7° nose up, wings level attitude.



## PRESSURIZATION

1. **BLEED AIR VALVES** – Both **ON/OPEN**.
2. **CABIN ALT** – Set 500 feet lower than field pressure altitude.
3. **CABIN PRESS** switch – **TEST**. Cabin climb/descent gauge indicates a descent.
4. **CABIN PRESS** switch – Release. Cabin climb/descent gauge indicates a climb, then stabilizes at zero climb.
5. Altitude selector – Set as required. Pressure altitude plus 200 feet.

## DEPARTURE BRIEFING

1. ATC clearance – Review.
  - a. Routing.
  - b. Initial altitude.
2. Departure procedure – Review.
  - a. Named departure procedure.
  - b. Obstacle clearance departure procedure / noise abatement procedure.
  - c. VFR departure route.
3. Copilot's duties – Review.
  - a. Adjust takeoff power.
  - b. Monitor engine instruments.
  - c. Power check at 65 knots.
  - d. Call out engine malfunctions.
  - e. Tune/identify all nav/comm radios.
  - f. Make all radio calls.

### TM 1-1510-218-CL

- g. Adjust transponder and radar as required.
  - h. Complete flight log during flight and note altitudes and headings.
  - i. Note departure time.
  - j. Retract gear and flaps as directed.
4. TOLD card – Review.
- a. Takeoff power.
  - b.  $V_1/V_r$ .
  - c.  $V_2 + 10$  KIAS (climb to 1500 feet AGL).
  - d.  $V_2/V_{yse}$ .

## TM 1-1510-218-CL

### ARRIVAL BRIEFING

1. Weather/altimeter setting.
2. Airfield/facilities – Review.
  - a. Field elevation.
  - b. Runway length.
  - c. Runway condition.
3. Approach procedure – Review.
  - a. Approach plan/profile.
  - b. Altitude restrictions/VDP.
  - c. Missed approach.
    - (1) Point.
    - (2) Time.
    - (3) Intentions.
  - d. Decision height or minimum descent altitude.
  - e. Lost communications.
4. Backup approach/frequencies.
5. Copilot's duties – Review.
  - a. Nav/comm set-up.
  - b. Monitor altitude and airspeeds.
  - c. Monitor approach.
  - d. Call out visual/field in sight.
6. Landing performance data – Review.
  - a. Approach speed.
  - b. Runway required.
7. Passenger briefing – As required.

TM 1-1510-218-CL

By Order of the Secretary of the Army:

Official:

ERIC K. SHINSEKI  
*General, United States Army*  
*Chief of Staff*

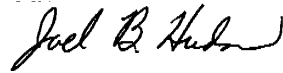

JOEL B. HUDSON  
*Administrative Assistant to the*  
*Secretary of the Army*  
0120501

PIN: 079164-000

This fine document...

Was brought to you by me:



## [Liberated Manuals -- free army and government manuals](#)

Why do I do it? I am tired of sleazy CD-ROM sellers, who take publicly available information, slap “watermarks” and other junk on it, and sell it. Those masters of search engine manipulation make sure that their sites that sell free information, come up first in search engines. They did not create it... They did not even scan it... Why should they get your money? Why are not letting you give those free manuals to your friends?

I am setting this document FREE. This document was made by the US Government and is NOT protected by Copyright. Feel free to share, republish, sell and so on.

I am not asking you for donations, fees or handouts. If you can, please provide a link to [liberatedmanuals.com](http://liberatedmanuals.com), so that free manuals come up first in search engines:

<A HREF=<http://www.liberatedmanuals.com/>>Free Military and Government Manuals</A>

- Sincerely  
Igor Chudov  
<http://igor.chudov.com/>
- [Chicago Machinery Movers](#)