

---

**DEPARTMENT OF THE ARMY LUBRICATION ORDER**

---

**ARMORED RECONNAISSANCE/AIRBORNE ASSAULT VEHICLE  
FULL-TRACKED 152MM GUN/LAUNCHER  
M551 (2350-00-873-5408) AND  
M551A1 (2350-00-140-5151)**

---

Headquarters, Department of the Army, Washington, DC  
1 May 1981

---

LO 9-2350-230-12, 28 February 1980, is changed as follows:

1. Remove old pages and insert new pages as indicated below. New or changed material is indicated by a vertical bar in the margin of the page. Added or revised illustrations are indicated by a vertical bar adjacent to the illustration identification number.

Remove	Insert
1 of 10 and 2 of 10	1 of 10 and 2 of 10
3 of 10 and 4 of 10	3 of 10 and 4 of 10
5 of 10 and 6 of 10	5 of 10 and 6 of 10

2. File this change sheet in front of the publication for reference purposes.

By Order of the Secretary of the Army:

E. C. MEYER  
*General, United States Army*  
*Chief of Staff*

Official:

J. C. PENNINGTON  
*Major General, United States Army*  
*The Adjutant General*

Distribution:

To be distributed in accordance with DA Form 12-37, Lubrication Order for Armored Reconnaissance/Airborne Assault Vehicle, Full-Track 152MM: M551/M551A1.

**ARMORED RECONNAISSANCE/AIRBORNE ASSAULT VEHICLE:  
FULL TRACKED 152-MM, M551 (2350-00-873-5408)  
AND M551A1 (2350-00-140-5151)**

Reference: TM 9-235. 23012 for turret  
TM 9-2350-230-20-1 for hull and suspension

Intervals are based on normal operation. Reduce to compensate for abnormal operation and severe conditions or contaminated lubricants. During inactive periods, intervals may be extended commensurate with adequate preservation.

Clean fittings, plugs, and surrounding areas before lubricating. Use mineral spirits; paint thinner (TPM) or dry cleaning Solvent (SD). Dry before lubricating. (For exceptions, see notes 1 and 2).

Use PL-S on all exposed unpainted surfaces of weapon.

Lubricate dotted arrow points on both sides of the equipment.

A reference to appropriate localized view (LV) is provided after each lubrication point entry.

**SERVICED FROM CREW COMPARTMENT**

LUBRICANT: INTERVAL

INTERVAL: LUBRICANT

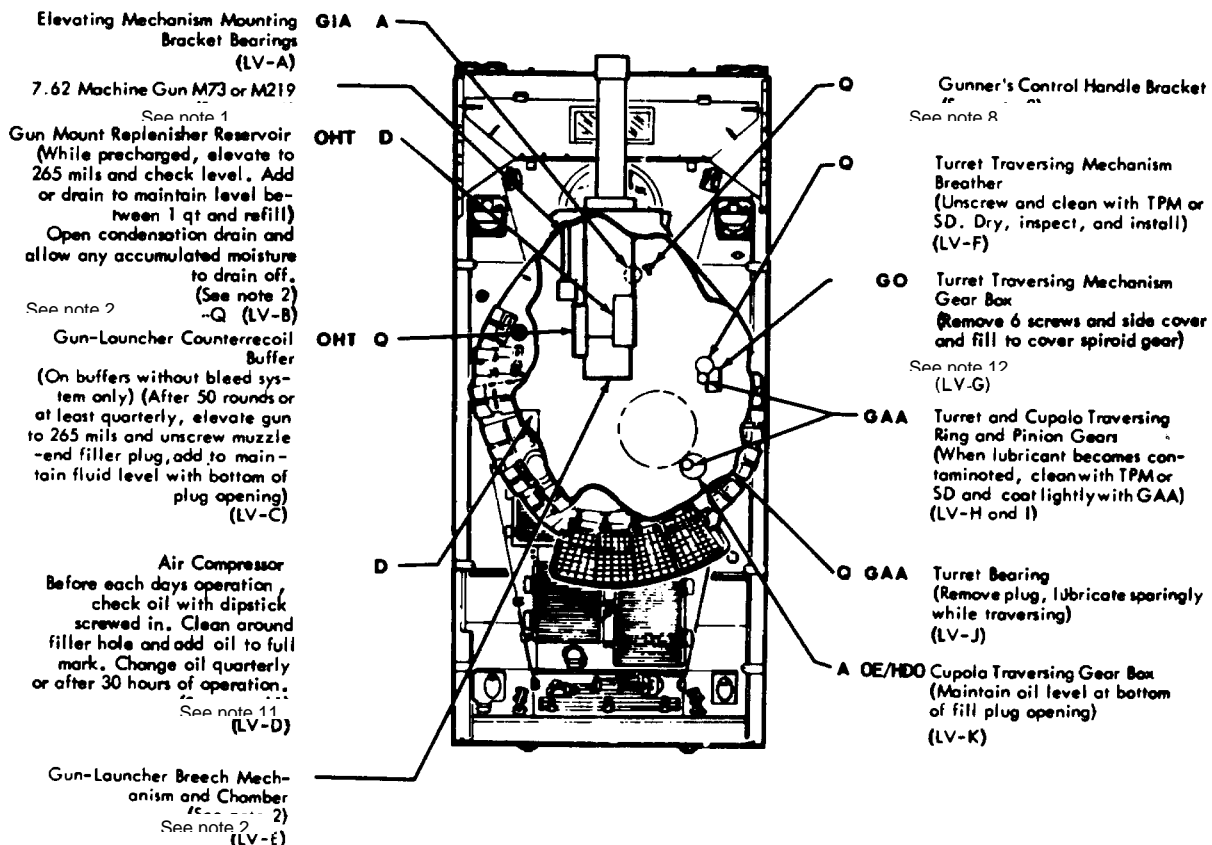

# SERVICED FROM ENGINE COMPARTMENT

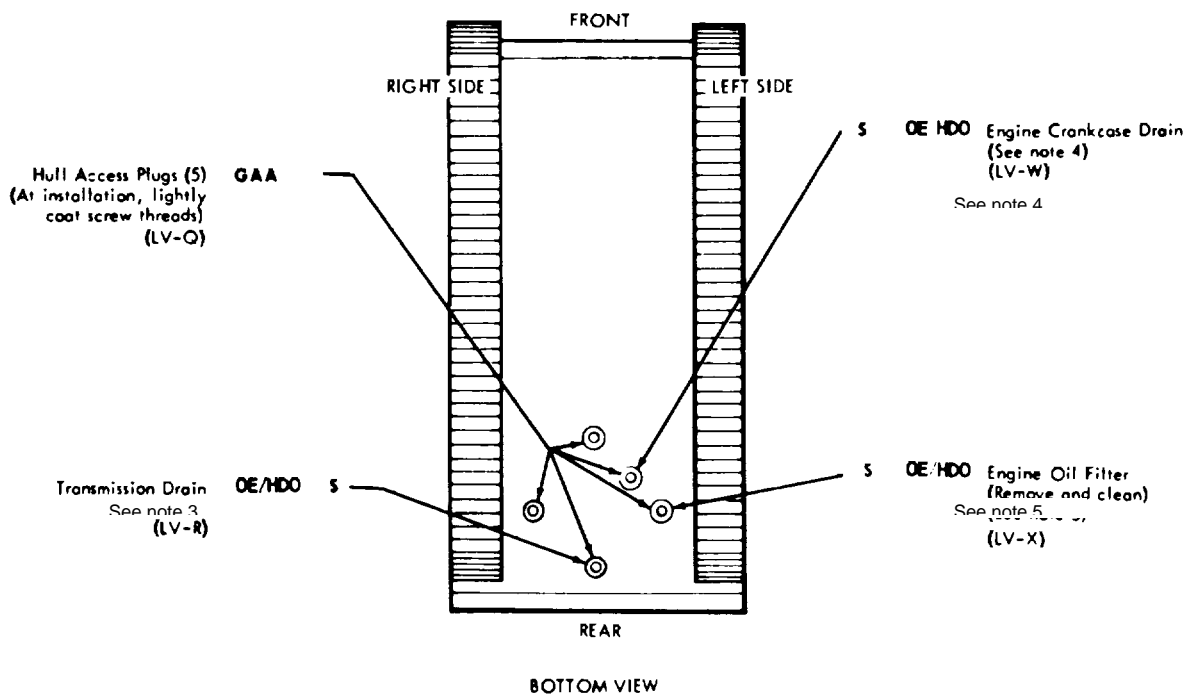
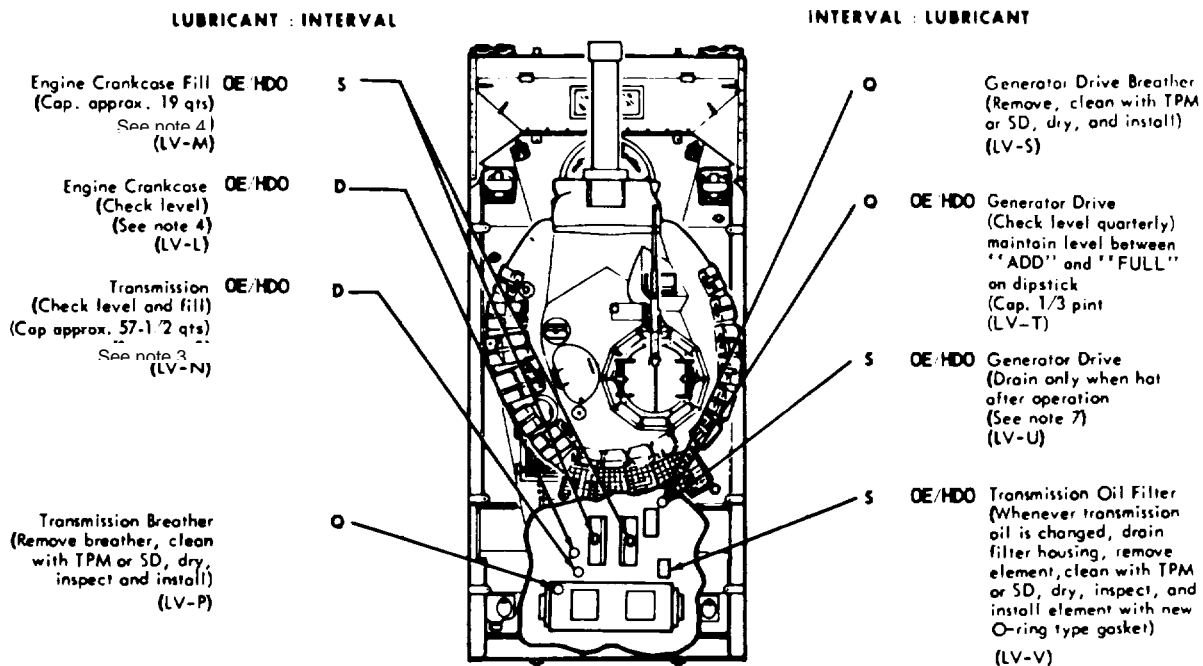

**SERVICED FROM OUTSIDE OF VEHICLE**

LUBRICANT : INTERVAL

INTERVAL : LUBRICANT

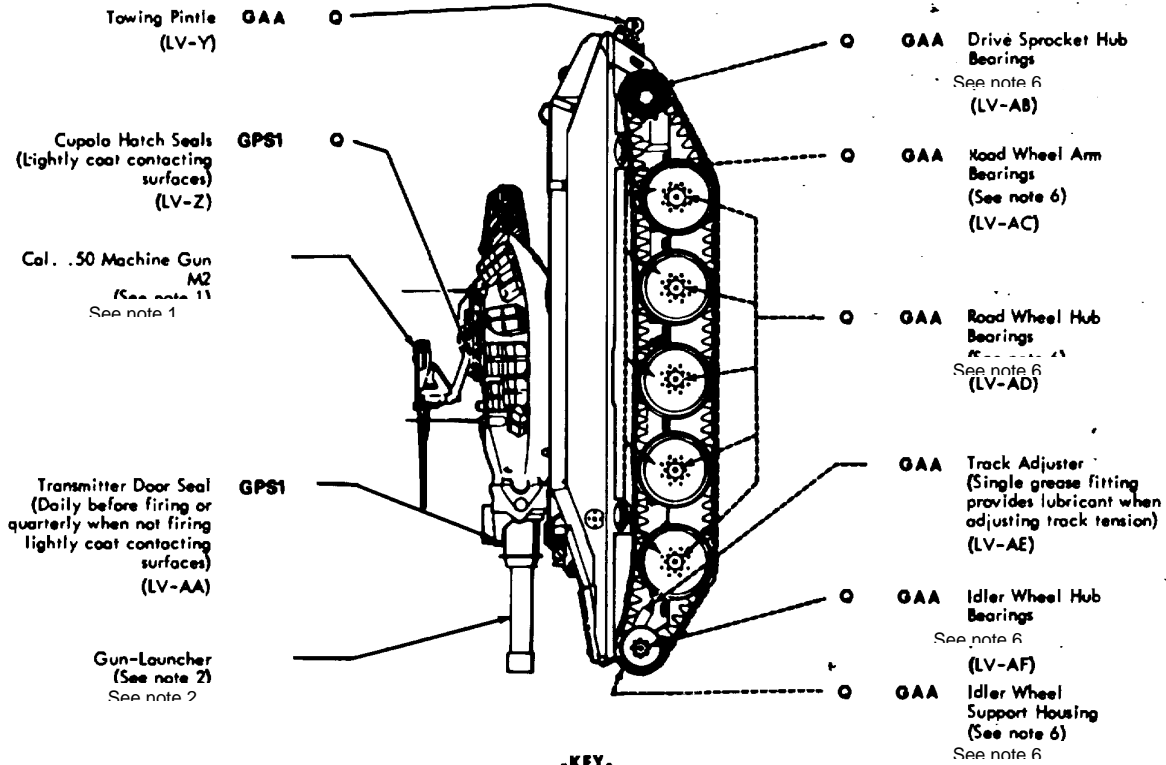

-KEY-

LUBRICANTS	EXPECTED TEMPERATURES			LUBRICANTS	INTERVALS
	Above +30°F	+40°F to -10°F	0°F to -65°F		
OE/HDO - Lubricating Oil, Internal Combustion Engine (Mil-L-2104c)	OE/HDO 30	OE/HDO 10	OEA	OEA - Lubricating Oil, Internal Combustion Engine, Subzero (MIL-L-46167)	D Daily Q Quarterly S Semi-annually A Annually
- Engine Crankcase	OE HDO 30	OE/HDO 10	OEA	LAW - Lubricating Oil, Weapons (Mil-L-14107)	
- Generator Drive Assembly	OE/HDO 30	OE/HDO 10	OEA	OHT - Hydraulic Fluid, Petroleum Base, (MIL-H-6083)	
- Cupola Traversing Gear Box	OE HDO 10	OE/HDO 10	OEA	RBC - Rifle Bore Cleaner (MIL-C-372)	
- Transmission	OE/HDO 10	OE/HDO 10	OEA	LSA - Lubricating Oil, Semifluid (Mil-L-46000)	
PL-5 - Lubricating Oil, General Purpose (VV-L-800a)	PL-5	PL-5	LAW	TPM - Thinner, Paint, Mineral Spirits (TT-T-291) Dry	
GO - Lubricating Oil, Gear, Multi-Purpose (Mil-L-2105c)	GO 80-90	GO 80-90	GO 75	SD - Dry Cleaning Solvent, Type II (P-D-680)	
GAA - Grease, Automotive and Artillery (Mil-G-10924c)	ALL TEMPERATURES			Lubricating Oil, Semifluid (Mil-L-46150)	
GIA - Grease, Aircraft and Instrument (Mil-G-23827)	ALL TEMPERATURES				
GPS1 - Grease, Pneumatic System (Mil-G-4343)	ALL TEMPERATURES				
GPS2 - Grease, Pneumatic System (VV-G-671)	ALL TEMPERATURES				

FOR ARCTIC OPERATIONS : REFER TO TM9-207

## NOTES

1. MACHINE GUNS - a. As soon as possible after firing thoroughly clean and lubricate weapon to maintain reliability and combat effectiveness. Disassemble gun into groups and assemblies. Clean all metal surfaces subject to powder fouling with RBC, wipe dry, and lubricate.

**CAUTION: Do NOT dip or submerge back plate in any solution. Use clean cloths to remove foreign matter. Do not lubricate back plate assembly of M73/M219 for danger of contaminating solenoid. Lubricate exterior of back plate assembly of M2 very lightly with oil saturated cloth.**

b. Clean all other components (except back plate assembly) with SD. Wipe dry and lubricate with PL-S.

c. On M73/M219 machine gun only, apply LSA to the following areas:

NOTE: Use LSA sparingly.

CAUTION: NEVER apply LSA to rate control slide components.

(1) In recesses or grooves where the belt feed slide and the feed cam ride in the cover assembly.

(2) In breechblock camways and in receiver rail and cartridge rammer grooves of the barrel extension. On all rollers and roller riding surfaces.

(3) On the receiver rails and in the breech closing, hammer cocking, breech opening, and breechblock roller camming groove areas of the receiver.

(4) After lubrication, function components by hand to allow the oil to spread.

d. Assemble the major groups and assemblies.

e. Use PL-S on all components (except solenoid and these areas of 7.62mm machine gun specified in C above) when temperature is expected to vary down to -30°F temporarily. When temperature is expected to remain from 0°F to -65°F consistently, use LAW instead of PL-S. LSA is applicable at all temperatures.

### 2. GUN/LAUNCHER NOTE

NOTE: Type I or II detent assembly. See applicable PMCS table in TM 9-2350-230-10. Lubricate with MIL-L-46150.

NOTE: Firing mechanism. After each 200 conventional rounds, remove firing mechanism and inspect probe and breech chamber for erosion. (table 11-1, TM 9-2350-230-12).

NOTE: (MB1E1 and M81 MOD) After firing 100 conventional rounds, clean check valve and lubricate with MIL-L-46150. (table 11-1, TM 9-2350-230-12). NOTE: Notify organizational maintenance to service discharge nozzles after firing 100 conventional rounds.

DAILY CLEANING AND LUBRICATION (AT COMPLETION OF DAYS FIRING SCHEDULE) - Immediately after firing, thoroughly clean all powder-contacting surfaces including rifling, obturator seal, obturator seal cavities in both tube and chamber, chamber threads, interior and front face, firing probe exposed surfaces, coupling threaded area, rear face of gun tube, and exposed cylindrical surface of spindle. Use a non-scratch pad or a stiff bristle brush with RBC. DO NOT USE ABRASIVES. M81 modified tubes must have evacuator chamber cleaned. Remove RBC and dry the surfaces with clean, lint-free soft rags. Visually inspect for complete removal of powder, dirt and rust. Blow out detent and scavenger valve cavities with dry compressed air. Apply coating of semifluid lubricating oil (MIL-L-46150) to the obturator seal, chamber and coupling threads, and exposed cylindrical surface of the spindle. (Shake oil before using.) Make sure that coupling and breech chamber buttress threads are well lubricated. Hand crank breech open and closed several times to check for smooth and normal operation. Replace obturator seal. Seal should rotate freely in its retained position and should require use of offset screwdriver for removal. If the seal cannot be retained in the tube but falls out of its retaining slot, the tube should be removed from service. Apply coating of PL to all other cleaned surfaces except firing probe which should never be lubricated. Clean and grease the ways of the torque bracket in which the gun torque key rides with GAA. Install muzzle plug and leave breech backed out, but not rolled over, to permit air circulation and reduce condensation. Gun/launcher tube should be depressed below 0 mils so that missile slot in bottom of tube will not channel moisture to the seal and chamber area. Before firing, wipe dry all areas except coupling and breech

chamber buttress threads. Maintain lubricant in buttress threads at all times. Remove and wash porous metal vent plug underneath rear cover. using RBC.

CLEANING AND LUBRICATION AT COMPLETION OF FIRING MISSION AND WHEN WEAPON WILL NOT BE USED FOR EXTENDED PERIODS - Perform daily cleaning and lubrication for three successive days following completion of firing mission. Visually inspect for complete removal of residue, rust and foreign matter. If gun is not to be used for a month or more, use a light grease GAA or MIL-G-23822 on the surfaces normally lubricated with PL or with MIL-L-46150.

NOTE: To functionally exercise CBSS, close breech and activate scavenging system manually to clear check valve discharge port in tube.

NOTE: If cannon will not be fired for one month or longer, use GIA.

NOTE: Replenisher reservoir condensation drain to be drained monthly, more often as extended firing or humid conditions require.

Monthly thereafter, when cannon is not being fired, clean with RBC, wipe dry and lubricate with GIA as indicated above. Before firing, wipe dry all areas except breech chamber and coupling buttress threads. Maintain lubricant on these threads at all times. Leave breech backed out, but not rolled over, to permit air circulation and reduce condensation. Gun/launcher tube should be depressed below 0 mils at all times when not in use.

M81 MOD - On third day after firing, or monthly if cannon is not being fired, remove evacuator. Clean all powder contacting surfaces with RBC. Wipe dry and apply a thin coating of PL-S. Apply GAA on threaded portions of evacuator and thrust collar before assembly.

2.1 RECOIL MECHANISM- When the gun launcher of vehicles in the hands of troops are not being fired for periods of 30 days or more the recoil mechanism will be exercised at least every 30 days to assure lubrication of sliding surfaces, seals and wiper. Recoil mechanism will be exercised at least 10 times for gun launcher tube distance of 6 to 8 inches with the recoil mechanism pressurized and the safe to fire indicator in the SAFE range. During interim periods the recoil mechanism will be kept pressurized (TM 9-2350-230-10).

3. TRANSMISSION- Doily, before starting engine, check transmission oil level. Oil level should be within OPERATING RANGE on bayonet-type gage. If not, add oil to bring level up to within OPERATING RANGE on gage. Do not fill above the upper limit of OPERATING RANGE. Drain every 1500 miles, 150 hours, or semiannually, whichever occurs first. Semiannual oil changes are to be coordinated with seasonal changes, where required. Drain only after operation. To drain, remove access plate on bottom of hull and remove plug from transmission housing. After draining, clean and install plug and cover plate. Refill transmission to within OPERATING RANGE on bayonet gage. Transmissions are delivered with preservative oil PE-1. Until the first scheduled oil change, OE/DO 10 may be added to PE-1 to maintain the proper oil level.

4. ENGINE CRANKCASE - Check oil level daily.

NOTE: Turn handle on dipstick top and loosen rubber seal on dipstick handle to prevent suction in tube causing an inaccurate, high reading. Fill to F mark on bayonet gage. Drain every 1500 miles, 150 hours, or semiannually, whichever occurs first. Semiannual oil changes are to be coordinated with seasonal changes, where required. To drain, remove cover plate on bottom of hull and remove oil sump drain plug. After draining, clean and install drain plug and cover plate. Refill crankcase to F mark on gage. Idle engine 5 minutes to fill oil passages. Stop engine, wait 5 minutes and recheck oil level. Engines are delivered with preservative oil as indicated on DD Form 1397. Until the first scheduled oil change, OE HDO oil may be added to maintain proper oil level. When using OE5 drain every 750 miles, 75 hours, or quarterly, whichever occurs first. At time of power plant removal, clean and coat threads on engine mounting bolts with GAA.

5. ENGINE OIL FILTER - Every 1500 miles, 150 hours, or semiannually, and at time of engine oil change. remove access plate on bottom of hull and remove oil drain plug from filter case. After the oil has drained, remove case from engine. Clean inside of case with TPM or SD. Install new filter element and gasket. Install filter case, drain plug, and cover plate.

**-NOTES-**

**6. SUSPENSION AND DRIVE**

General Procedures for all Components

Lubricate quarterly or every 750 miles, whichever comes first, and at any time suspension is exposed to water contamination. Make sure all fittings are properly tightened (12-16 ft - lb). Clean fittings, then lubricate with GAA until grease comes out of relief fitting. Avoid dropping grease on track. Refer to TM-9-2350230-20.1 for illustrations and for lubrication procedure when components are disassembled.

Drive Sprocket Hub, Idler Hub, and Idler Spindle Housing

On idler wheel and drive sprocket hub, position grease fitting at 6 o'clock position. Clean fittings and lubricate with GAA until grease comes out of relief fittings. If idler spindle housing is provided with fittings, lubricate with GAA until grease comes out of relief fitting. If fitting are not provided, housing is repacked at overhaul and requires no lubrication at Q check.

Road Wheel Arm Spindle and Upper Road Wheel Arm Housing-

Lubricate road wheel arm spindle though grease fittings in center of hub until grease comes out of relief fitting behind road wheel. Lubricate upper housing until grease comes out of relief fitting on housing.

**7. GENERATOR DRIVE**

Remove generator and drive assembly from vehicle and take to a suitable workbench.

Loosen generator drive nuts, rotate drive assembly counterclockwise and remove combined drive assembly, baffle, and pulley from key slots in generator.

Turn upside down and drain all old oil from drive assembly, (at first oil change only, flush out drive assembly with diesel fuel and drain completely to remove machining chips and filings).

Reverse above procedure for installation, and fill drive assembly after the complete assembly is reinstalled on vehicle. (fill with OE HDO so the oil level shows between " ADD" and "FULL" marker on dipstick.

**8. OIL CAN POINTS** - Quarterly or as required, lubricate turret and cupola hatch cover hinges; hull access covers surfboard hinges and linkage; hatch and seat mechanism; ammunition stowage rocks hinges and pins; turret traverse lock; periscope covers latches and hinges; machine gun cradle pivot and pintle support; 7.62mm ammunition feed ratchet; trunnion end of periscope linkage; transmitter door control assembly, linkage, and hinge; exterior intercom access door hinge and latch; and shaft of gunner's control handle bracket.

**9. LUBRICATE AT TIME OF ASSEMBLY OR INSTALLATION**  
Engine mounting clamps; starter; generator; fan drive clutch and bearings; air cleaner; elevating and traversing mechanism internal component; trunnion bearings; ors ion bar splines, anchor, and plugs; driver's hatch support bearings; drive shaft splines; idler wheel support housing; breech mechanism internal parts; and azimuth indicator.

**10. DO NOT LUBRICATE** - Bilge pumps; personnel heater; ventilating blower; shock absorbers; M37 periscope rotatable mount; grenade launcher solenoids; gun and turret control handles; machine gun back plate assemblies; control cables od linkages for steering, pivot steer, transmission shifting, engine throttle, brake, fuel shut-off, fixed fire extinguisher, and speedometer tachometer system.

**11. COMPRESSOR** - Reduce drain-and-refill time-interval under extreme operating conditions, such as excessively high or low temperatures, prolonged operating periods, operation in sand or dust, or immersion in water.

**CAUTION: Use only Aircraft Instrument Oil NSN 9150-00985-7099 (MIL-L-23699).**

**12. GEARS** - Where GO is used, change lubricant only when required by maintenance repair action, contaminated by water, or other foreign material.

**13. REPORTING OF ERROS** - You can improve this Publication by calling attention to errors and by recommending improvements and stating reason for the recommendation. Your letter or DA Form 2028, Recommended Changes to Publications and Forms, should be mailed directly to: Commander, US Army Tank-Automotive Command, ATTN: DRSTA-MBC, Warren MI 48090. A reply will be furnished directly to you.



ELEVATING MECHANISM  
MOUNTING BRACKET BEARINGS

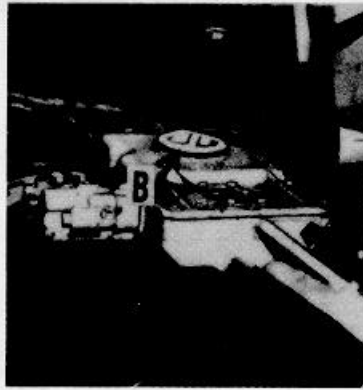

GUN MOUNT REPLENISHER RESERVOIR

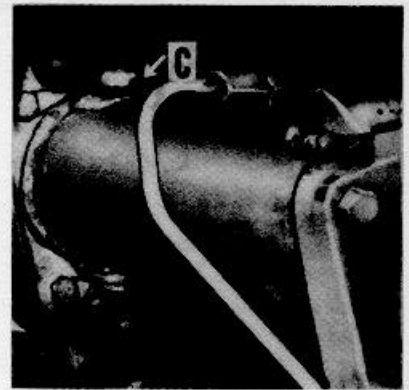

GUN-LAUNCHER COUNTERRECOIL  
BUFFER

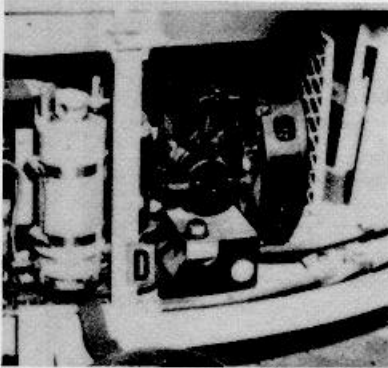

AIR COMPRESSOR

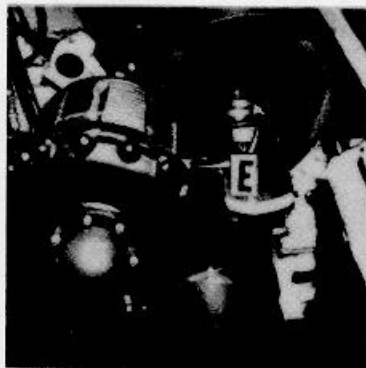

GUN-LAUNCHER BREECH MECHANISM  
AND CHAMBER

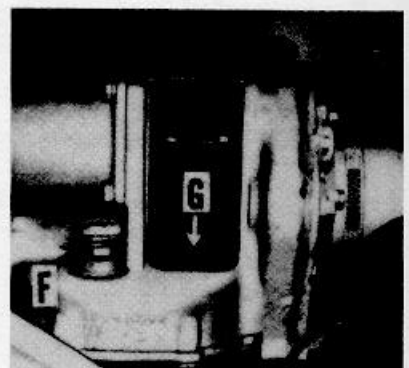

TURRET TRAVERSING MECHANISM  
BREATHER AND GEAR BOX

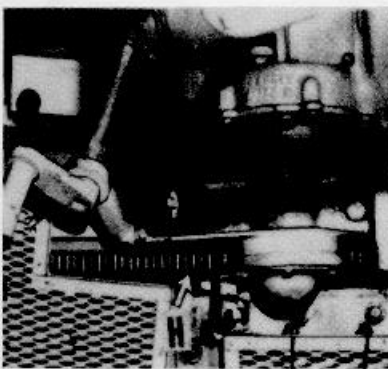

TURRET TRAVERSING RING AND  
PINION GEAR

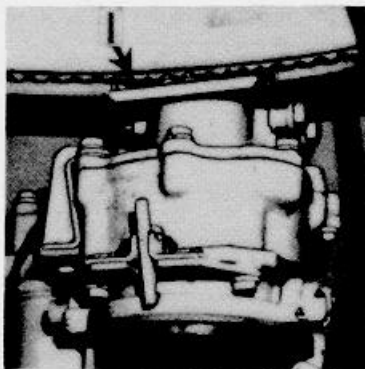

CUPOLA TRAVERSING RING AND  
PINION GEAR

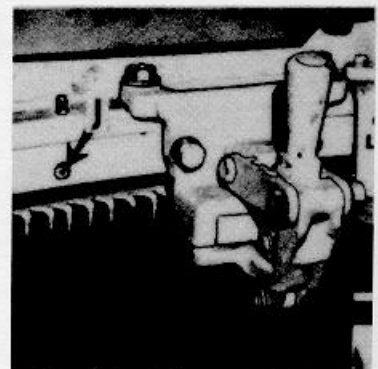

TURRET BEARING

LOCALIZED LUDRICATION VIEWS

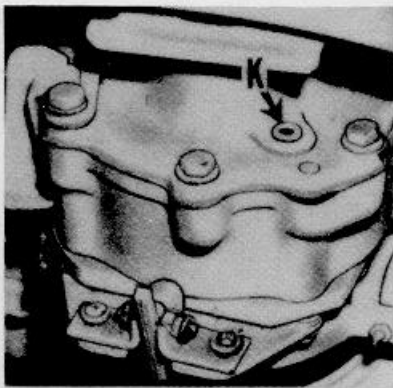

CUPOLA TRAVERSING GEAR BOX

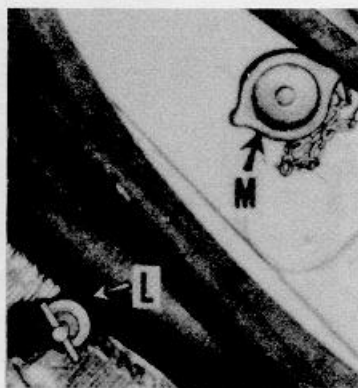

ENGINE CRANKCASE LEVEL (L) AND  
FILL (M)



TRANSMISSION LEVEL/FILL

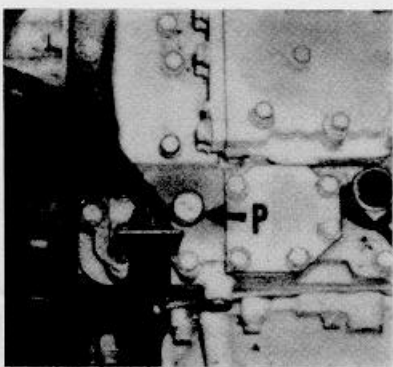

TRANSMISSION BREATHER

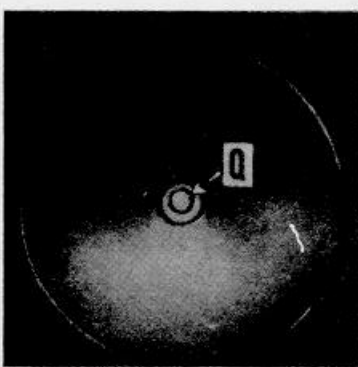

HULL ACCESS PLUGS (5)

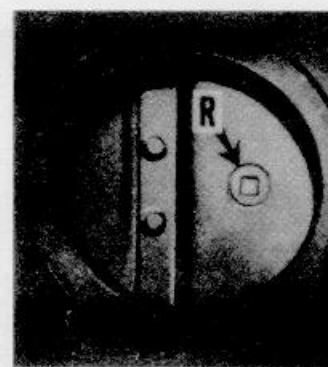

TRANSMISSION DRAIN

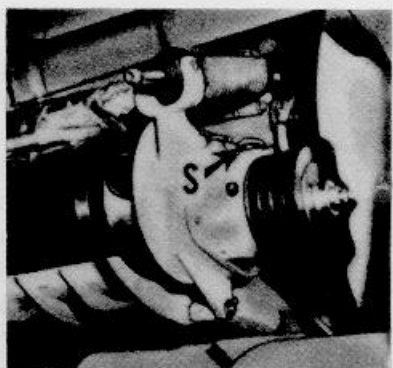

GENERATOR DRIVE BREATHER, CHECK  
LEVEL (S)

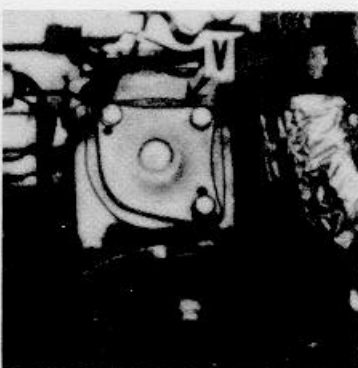

TRANSMISSION OIL FILTER

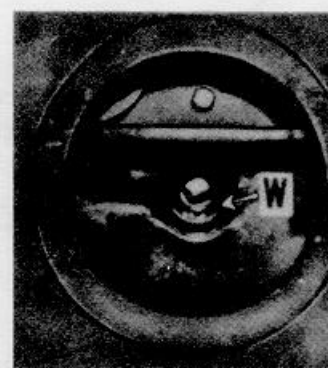

ENGINE CRANKCASE DRAIN

### LOCALIZED LUBRICATION VIEWS





ENGINE OIL FILTER

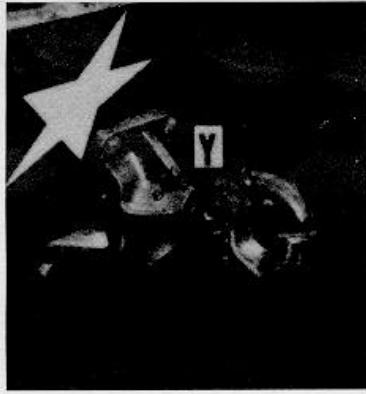

TOWING PINTLE

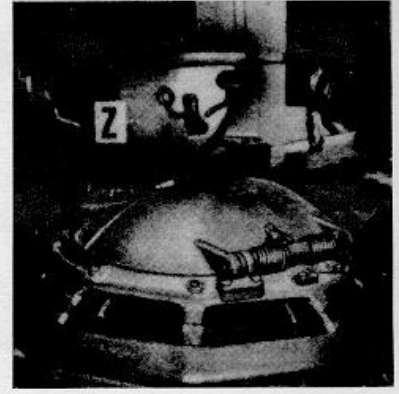

CUPOLA HATCH COVER SEALS

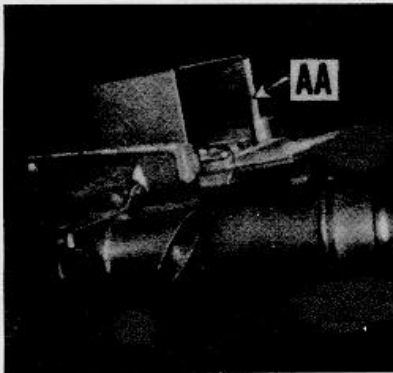

TRANSMITTER DOOR SEAL

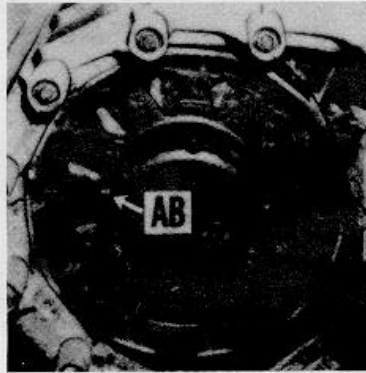

DRIVE SPROCKET HUB BEARINGS

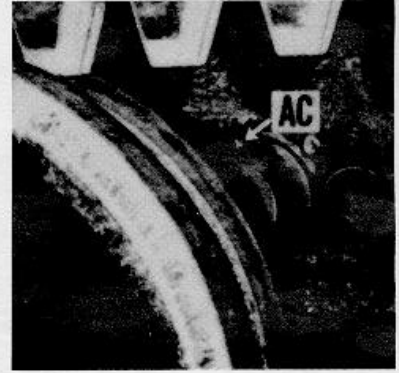

ROAD WHEEL ARM BEARINGS



ROAD WHEEL HUB BEARINGS

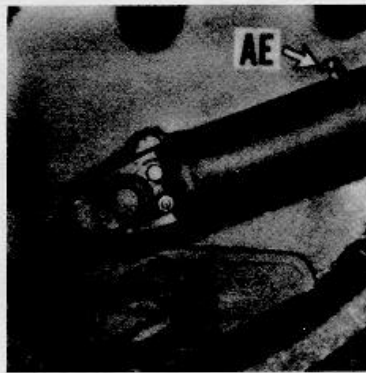

TRACK ADJUSTER

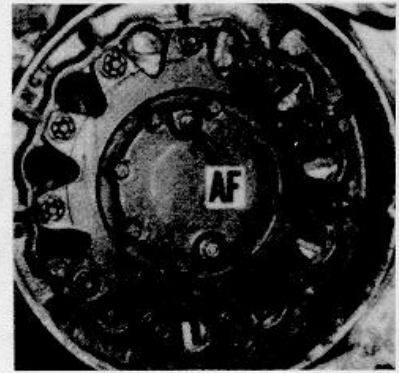

IDLER WHEEL HUB BEARING

LOCALIZED LUBRICATION VIEWS



LOADER'S COVER HATCH HINGES AND LATCH

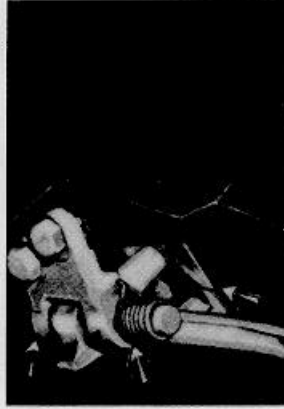

DRIVER'S HATCH LEVER AND HOOKS



CUPOLA HATCH HINGES AND HOOKS

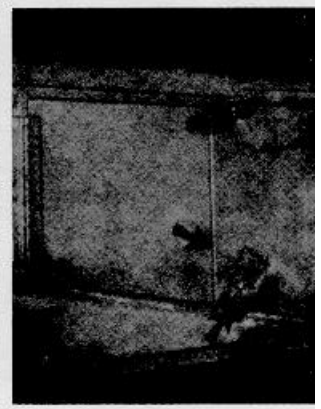

HULL ACCESS COVERS



SURFBOARD HINGE AND LINKAGE

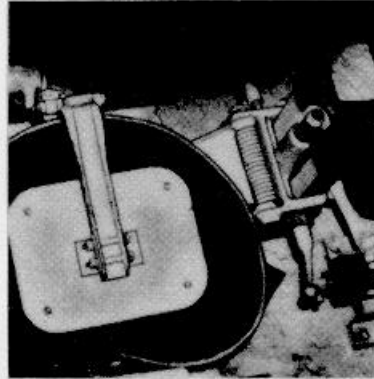

SEAT MECHANISMS (DRIVERS SHOWN)



AMMUNITION STOWAGE RACK HINGES AND PINS

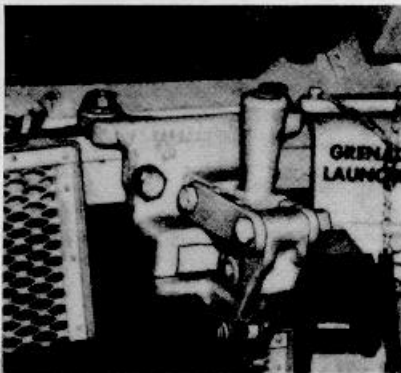

TURRET TRAVERSE LOCK

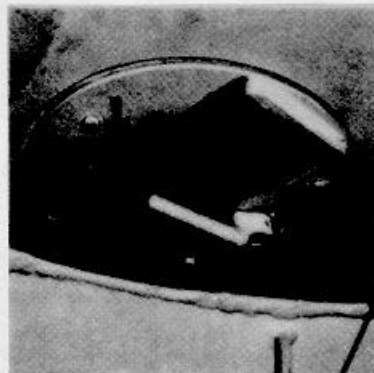

LOADERS PERISCOPE LATCH



GUNNERS PERISCOPE COVER HINGE

OIL CAN POINTS - LOCALIZED VIEWS (SEE NOTE 8)

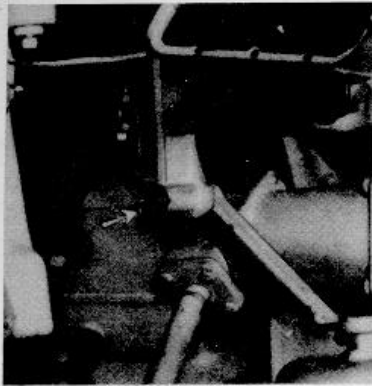

GUNNER'S PERISCOPE LATCH AND LEVER



MACHINE GUN CRADLE PIVOT

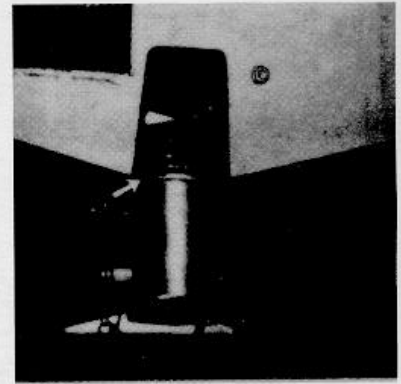

MACHINE GUN CRADLE PINTLE

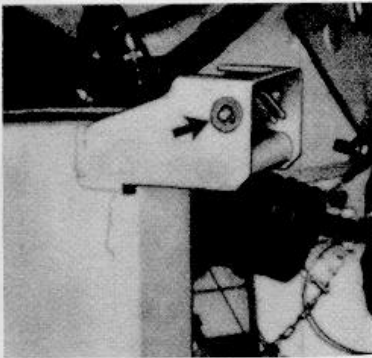

7.62MM AMMUNITION FEED RATCHET



TRUNNION END OF PERISCOPE LINKAGE

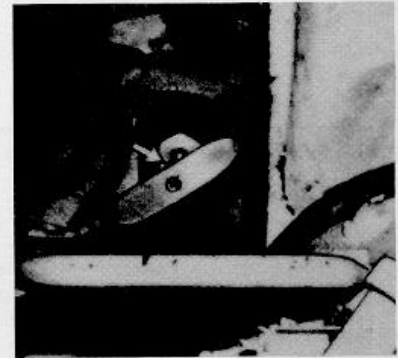

TRANSMITTER DOOR CONTROL ASSEMBLY

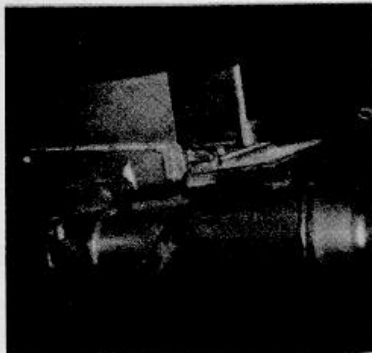

TRANSMITTER DOOR HINGE AND LINKAGE



EXTERIOR INTERCOM ACCESS DOOR HINGES AND LATCHES



SHAFT OF GUNNER'S CONTROL HANDLE BRACKET

OIL CAN POINTS - LOCALIZED VIEWS (SEE NOTE 8)

Copy of this Lubrication Order will remain with the equipment at oil times. Instructions contained herein are mandatory.

By Order of the Secretary of the Army

Official

J. C. PENNINGTON  
Major General, United States Army  
The Adjutant General

\* U.S. GOVERNMENT PRINTING OFFICE 1994 0 - 300-721 (00337)  
LO 9-2350230-12 OF

E. C. MEYER  
General United States Army  
Chief of Staff



**PIN: 011893-001**

This fine document...

Was brought to you by me:



## [Liberated Manuals -- free army and government manuals](#)

Why do I do it? I am tired of sleazy CD-ROM sellers, who take publicly available information, slap “watermarks” and other junk on it, and sell it. Those masters of search engine manipulation make sure that their sites that sell free information, come up first in search engines. They did not create it... They did not even scan it... Why should they get your money? Why are not letting you give those free manuals to your friends?

I am setting this document FREE. This document was made by the US Government and is NOT protected by Copyright. Feel free to share, republish, sell and so on.

I am not asking you for donations, fees or handouts. If you can, please provide a link to [liberatedmanuals.com](http://liberatedmanuals.com), so that free manuals come up first in search engines:

<A HREF=<http://www.liberatedmanuals.com/>>Free Military and Government Manuals</A>

- Sincerely  
Igor Chudov  
<http://igor.chudov.com/>
- [Chicago Machinery Movers](#)